



Sobna vrata

Drvena vrata vrhunske stolarske kvalitete
NOVO: DesignLine Concepto Lan

HÖRMANN

Otkrijte novu udobnost stanovanja s visokokvalitetnim sobnim vratima

Naš dom je naše središte življenja,
naša zona odmaranja i naša oaza u
kojoj se osjećamo dobro.

Dičimo se kao obiteljska tvrtka koja
svojim proizvodima made in Germany
stvara osjećaj doma. Tome doprinose
i kvalitetna sobna vrata koja Vašem
domu daju posebnu notu stanovanja.

Klasična ili moderna, bijeli lak ili boja
bukve, sa staklenim elementima ili
aplikacijama od plemenitog
čelika – Hörmann nudi sobna vrata
koja odgovaraju Vašoj osobnosti i
interijeru.





SADRŽAJ

- 6 Zašto odabrati Hörmann
- 12 Izvedbe vratnog krila
- 14 BaseLine
 - Duradecor glatki
 - Duradecor struktura
 - Lak
 - Drveni furnir
- 18 DesignLine Concepto
 - Ultra mat
 - Gloss
 - Strukturirano kamen škriljevac
 - Lan ■ **NOVO**
- 26 DesignLine
 - Stripe
 - Groove
 - Steel
 - Plain
 - Rail
 - Pure
- 42 ClassicLine
 - Georgia
 - Carolina
 - Montana ■ **NOVO**
 - Kontura ■ **NOVO**
 - Virginia
- 52 GlassLine
- 64 Namjenska vrata
- 70 Bežična brava za vrata SmartKey
- 72 Motor PortaMatic
- 74 Čelični dovratnik VarioFix
- 76 Izvedbe kliznih vrata
- 78 Svijetli otvor / Bočni elementi / Nadsvjetla
- 80 Ručke i okovi
- 83 Okovi za potpuno staklena vrata
- 84 Ručke za klizna vrata
- 86 Površine
- 90 Konstrukcije vrata i dovratnika
- 92 Tablica
- 94 Tehnički podaci

Prikazana vrata djelom imaju dodatnu opremu i ne odgovaraju uvijek standardnoj izvedbi. Prikazane boje i površine iz tiskarskih razloga nisu sasvim vjerodostojne. Sve opisane boje odnose se na RAL kartu boja.

Zaštićeno autorskim pravima. Pretisak, čak i samo djelomičan, dopušten je samo uz našu dozvolu. Pridržano pravo na izmjene.

Ovako ćete pronaći odgovarajuća sobna vrata

Prilikom kupnje sobnih vrata morate donijeti neke odluke. Koju izvedbu vratnog krila biram? Koji materijal odgovara mom stilu i mojim potrebama?

Kako biste prilikom kupnje vrata imali pregled svih mogućnosti, naveli smo najvažnije detalje, koje trebate uzeti u obzir prilikom kupnje sobnih vrata:



Odabir odgovarajuće površine

Većina proizvođača nude sobna vrata od pravog drvenog furnira, s lakiranim ili CPL slojem. Baš se u kućanstvima s djecom i kućnim ljubimcima preporučuje postavljanje izrazito robusnih Duradecor površina. Kvalitetne površine se ujedno i vrlo lako čiste. Savjet: Pitajte svog predstavnika za 4Protect na udarce otporne rubove, jer oni će dugo vremena ostati sigurni i neoštećeni.

Unutarnje vrijednosti su bitne

Odabir ispune vratnog krila ovisi o tome koliko se vrata često koriste i kako su vrata trajna. Najbolji odnos cijene i učinkovitosti dobivate s uloškom od ploče cijevaste iverice. Hörmann ujedno nudi kvalitetna vratna krila od pune iverice kao i povoljnu cijevastu ivericu i ispune od kartonskog saća. Ostale informacije naći ćete na stranici 93.

Oblik vratnog krila

Odabrati se može između vratnog krila s preklopom i vratnog krila koje se zatvara u ravnini s štokom. S preklopom znači da rub vratnog krila u zatvorenom stanju malo naliježe na dovratnik. U ravnini znači da vratno krilo u zatvorenom stanju čini ravnomjernu površinu s dovratnikom. Ostale informacije naći ćete na stranici 12.

Tko se odlučuje za klasično uređenje, taj odabire varijantu sa žljebićima, pri čemu čeaona varijanta je odabir onih koji se odlučuju za moderan stil uređenja.

Vrste okova – ručke vrata, rozete i okovi

Osim širokog izbora vrata, raznolik je izbor garnitura kvaka, koje možete odabrati prema svom ukusu. Garniture ručke sastavljene su od ručke i rozete. Kvae i brave dostupne su u tvrtki Hörmann u različitim oblicima i izvedbama od plemenitog čelika. Sjajne, matirane ili kombinacija navedenog: odaberite odgovarajuću garnituru kvaka po svom ukusu. Tko želi moderan izgled, može odabrati ručke vrata koje su postavljene u ravnini s površinom vratnog krila – elegantan izgled bez provrta za ključanicu. Uz to odgovaraju dobro prekriveni okovi, koji nevidljivo spajaju vratno krilo i okvir vrata.

Dovratnik vrata

Prema drvenim vratima možete odabrati drveni okvir ili dovratnik u kvadratnoj ili obloj izvedbi. U kućanstvima s djecom, preporučeno je kombinirati sobna vrata s dovratnikom od čelika. Ona su izrazito robusna, stoga će izdržati "sudare" s bobby vozilom, usisavačem ili s sanducima za pića. Optički ne možete razlikovati čelični VarioFix dovratnik od dovratnika od drveta.



Kvalitetno vratno krilo od pune iverice



Elegantna ručka za vrata u ravnini površine vratnog krila bez provrta za ključanicu



Robusni čelični dovratnik VarioFix

„Ugled treba
zaslužiti.“

August Hörmann

Baš kao što je to njezin osnivač želio, tržišna marka Hörmann objedinjuje kvalitetu i znanje. Tradicija ove obiteljske kompanije duga je 80 godina, pri čemu se može smatrati stručnjakom za građevinske elemente i pouzdanim partnerom u gradnji i modernizaciji. Hörmann nije bez razloga u području sobnih vrata jedan od najuspješnijih proizvođača u Europi. Stoga pri odabiru Hörmann sobnih vrata možete imati mirnu savjest.



1 Kvalitetni proizvodi iz Njemačke

Hörmann sam razvija konstrukcije za vrata i dovratnike. One se proizvode u modernoj tvornici u Njemačkoj u skladu sa svim standardima za kvalitetu, okoliš, energiju te sigurnost i zaštitu na radu prema DIN EN ISO 9001, 14001, 50001 i BS OHSAS 18001. U tu svrhu naši stručni suradnici intenzivno rade na novim proizvodima, **daljnjem razvoju i poboljšanju detalja**. Na taj način stvaramo patente i jedinstvene proizvode.



2 Sobna vrata koja traju generacijama

Vjerujemo u naše proizvode i bezuvjetno osiguranje kvalitete. Na taj način moći ćete dugi niz godina uživati u Hörmann sobnim vratima te **doslovno odabirete, za svoj dom, „vrata za cijeli život“**.

3 Briga o budućnosti

Hörmann nastoji pružiti primjer drugima. Stoga tvrtka **do 100 % svoje potrebe za energijom pokriva iz ekoloških izvora**. Inteligentnim i certificiranim sustavom upravljanja energijom, CO₂ neutralnim slanjem pošiljaka kao i reciklažom sirovina **godišnje se uštedi 40000 tona CO₂**. Uz navedeno Hörmann nudi proizvode za održiv razvoj.



4 U ravnini površine: Planar ručke

Za **posebno elegantan izgled** opremite Vaša vrata s Planar ručkama. Na one koje su orijentirani na dizajn posebno će oduševiti **u potpunosti ulegnuta rozeta u ravnini**, savršeno uklopljena u vratno krilo. Savršena elegancija postignuta je vratima u ravnini s dovratnikom i sa skrivenim okovima. Još jedan, fini detalj: izbjegavanjem otvora za ključanicu, dizajn je minimaliziran i time je izgledom još elegantniji.

Daljnje informacije naći ćete na stranici 80.

5 4 × 4-Koncept: DesignLine Concepto

Promišljeno i raznovrsno: Vrata **iz linije DesignLine Concepto nude brojne mogućnosti za oblikovanje Vašeg doma**. Kombinirajte kvalitetne površine u izvedbi ultramat, sjaj (visoki sjaj), četkanje ili kao novitet u izvedbi lana s varijantama u boji poput prometno bijele, sive, antracit sive ili u novoj nijansi sivo smeđe boje.

Više detalja o robusnim površinama koje se lako održavaju pročitajte na stranici od 19.



6 Nano sloj: potpuno staklena vrata

Želite svoj dom prožeti svjetlošću? Tada su naša staklena vrata pravi odabir za Vas. Osim elegantnog izgleda vrata GlassLine linije vrlo su praktična za održavanje: svi motivi s pjeskarenim staklom imaju nanosen nano sloj koji sprječava primanje otisaka prstiju po površini.

Motivi poput DesignLine Groove i Concepto Za savršenu mješavinu drvenih i staklenih vrata uz motive DesignLine Groove i DesignLine Concepto nudimo Vam izgledom usklađena, potpuno staklena vrata.

7 Vidjeti i osjetiti: Duradecor struktura

S fino ćete strukturiranom površinom **osjetiti ono što vidite**. Uzorak drva koji se utiskuje u vratno krilo, čini karakterističnu drvenu Duradecor strukturu površine opipljivom. Time se naglašava **udobna i prirodna atmosfera stanovanja** u Vašem domu te se ujedno izrazito lako održava i otporna je.

Daljnje informacije naći ćete na stranici 87.

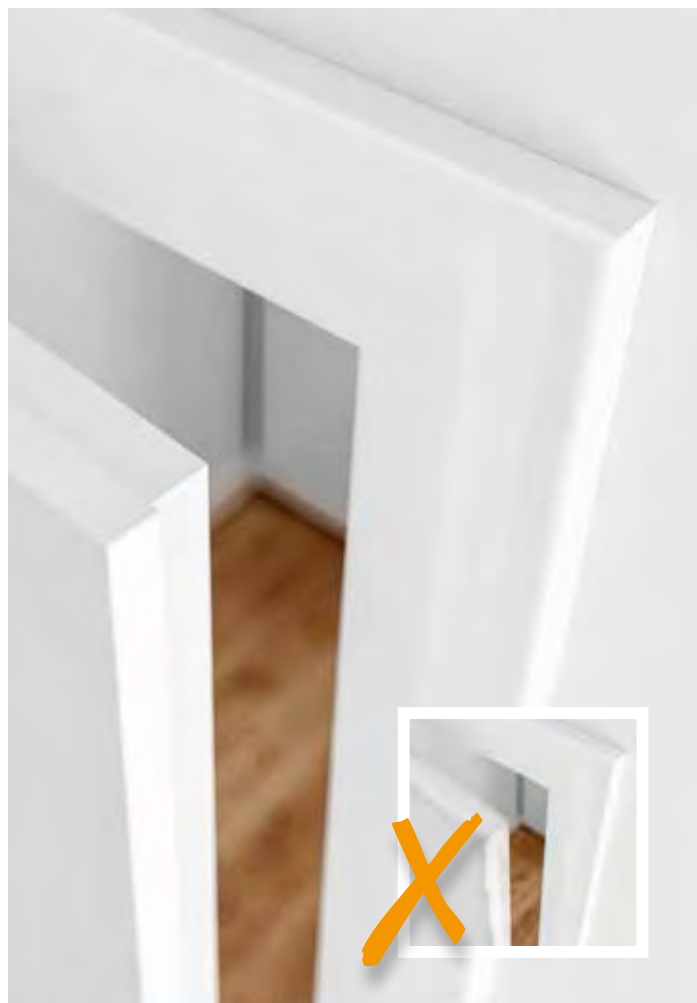

8 Krajnje otporna na udarce: Duradecor površina

Oduševit će Vas kvalitetna površina: Duradecor će Vas očarati **izrazitom otpornošću na udarce, koja je 48 % bolja** od prosjeka testirani CPL-površina drugih proizvođača. Površina je ujedno neosjetljiva, jednostavna za njegu i otporna na visoke temperature, čime je zajamčen dugi vijek vrata.

Daljnje informacije naći ćete na stranici 86.



9 Trajna zaštita ruba: 4Protect

Naša obrađena vrata s četvrtastim rubovima i naša vrata u ravni dovratnika s Duradecor površinom izvedenom u boji bijelog laka, svijetlo sivoj boji, antracit sivoj ili sivo smeđoj boji, **serijski su opremljena s kvalitetnom 4Protect zaštitom ruba.**



Na taj način su Vaša unutarnja drvena vrata trajno zaštićena od svakodnevnih opterećenja stoga Vi možete u njima uživati puno dulje.

Daljnje informacije naći ćete na stranici 13.



10 Kvalitetno i elegantno: Drveni dovratnik

Naši drveni dovratnici imaju **lijepi obli okvir** i **radijus ruba od 3 mm** ¹. Ispuna u obliku daske debljine 25 mm ² i robusna Duradecor površina ³ zaslužni su za **kvalitetan i elegantan izgled** Vaših novih sobnih vrata.

Daljnje informacije naći ćete na stranicama 90 – 91.

11 Lijepo i robusno: Okvir s čeličnom ispunom

VarioFix naziv je okvira s čeličnom ispunom, koji nudi brojne prednosti: a s podesivim ukrasnim žljebićem montira se **sasvim jednostavno**, poput drvenog dovratnika. Dodatno je zahvaljujući dobrim svojstvima postojanosti **izuzetno dugotrajan**. I po pitanju dizajna ističe eleganciju bez vidljivih savijanja. Čelični dovratnik VarioFix je s određenom dubinom dovratnika od 55 mm **izgledom ujednačenim drvenom dovratniku**.



Izvedba vratnog krila sa zaobljenim rubovima

Izvedba s okruglim rubovima

Tko polaže vrijednost na harmoničan izgled s ovim odabirom neće pogriješiti: vratno krilo naliježe na dovratnik i zaobljenim rubovima vratnog krila stvara **harmoničan izgled**. Izvedba vrata sa zaobljenim rubovima dostupna je za sva drvena unutarnja vrata, osim za linije DesignLine Stripe i ClassicLine Montana.

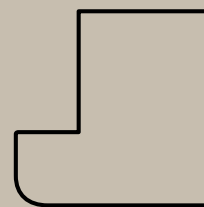

Horizontalni presjek vratnog krila



Obradeno vratno krilo sa četvrtastim rubovima i zaštitom ruba 4Protect

Izvedba sa četvrtastim rubovima

Ovu izvedbu Vam možemo preporučiti ako ste pobornik dizajna ravnih linija. Vratno krilo naliježe i ima **lijep četvrtasti rub**. Dostupno je za sva drvena unutarnja vrata osim za linije ClassicLineVirginia i ClassicLine Carolina. Kod Duradecor površine s 4Protect zaštitom ruba i u lakiranoj površini, ova izvedba očarava **sa savršenim izgledom bez fuga**.

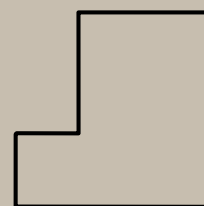

Horizontalni presjek vratnog krila



Vratno krilo koje naliježe na dovratnik

Čvrsto preklopljena vrata

Želite u svom domu **ekskluzivan izgled vrata s prijelazom u ravnini** dovratnika? Tada Vam predlažemo vratno krilo koje se naslanja na dovratnik i koje je usklađeno u moderan stil življenja. Ova izvedba je dostupna za sva drvena vrata, osim za linije ClassicLine Virginia i ClassicLine Carolina. Kod Duradecor površine s 4Protect zaštitom ruba i u lakiranoj površini, ova izvedba očarava **sa savršenim izgledom bez fuga.**

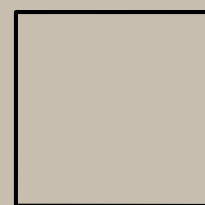

Horizontalni presjek vratnog krila



Savršeni izgled bez fuga za posebno kvalitetan izgled vrata

Zaštita ruba 4Protect

Zaštita sve četiri strane ruba kod **vrata koja se zatvaraju u ravnini i vrata s preklpom s četvrtastim rubovima** u Duradecor površini bijeli lak, svijetlo sivoj, antracit, sivo smeđoj, Bütte bijela, Bütte svjetlo siva, bijeli jasen i četkana bijela oduševit će Vas očaravajućim svojstvima:

1. Izrazito dobra otpornost na udarce
2. Izrazita otpornost na habanje
3. Izrazita otpornost na ogrebotine
4. **Savršeni izgled bez fuga**, odnosno, za razliku od uobičajenih vrata u ovom slučaju vidljive fuge ne narušavaju kvalitetan izgled vrata.



Uobičajeno vratno krilo s vidljivom fugom



Bezvremenska elegancija: BaseLine drvena unutarnja vrata

Puno pažnje polažete na osjećaj udobnosti u Vašem domu? Tada su modeli vrata iz linije BaseLine pravi odabir za Vas. Vratno krilo s ravnom ili preklopnom izvedbom, kombinirano sa željenom bojom ili dekorom po želji stvara ugodnu atmosferu doma, koji pozva na opuštanje.









Sva drvena unutarnja vrata iz linije BaseLine dostupna su u kvalitetnoj izvedbi površina Duradecor glatka površina, Duradecor strukturirana površina, lakirana izvedba i furnir od pravog drveta. Kako bi ostvarili potpunu harmoniju s Vašim unutarnjim uređenjem doma, na raspolaganju Vam stoje brojne mogućnosti odabira boje i dekora. Za još veću individualnost nudimo Vam široku paletu boja po želji, za HPL površinu. Ili želite sami dizajnirati svoja unutarnja vrata? U tom slučaju odaberite foliju za grundiranje. Sve mogućnosti otkrijte na sljedećim stranicama.



Duradecor glatki

Za vaš dom je pravi odabir Duradecor površina koja je izrazito otporna na udarce. Ovdje ćete zasigurno pronaći unutarnja vrata po Vašem ukusu – bilo da je riječ o bijeloj lakiranoj površini, modernoj sivoj ili površini u udobnoj boji drveta, sa ili bez nadsvjetla. Vrata koja se zatvaraju u ravnini i vrata s preklpom s četvrtastim rubovima s Duradecor površinom boje bijelog laka, svijetlo sivoj boji, Bütte bijeloj, Bütte svjetlo sivoj te pepeljasto bijeloj serijski su opremljena s kvalitetnom 4Protect zaštitom ruba.

Boje i dekori

-  Bijeli lak RAL 9016
-  Svijetlo siva RAL 7035
-  Bijela
-  Svijetlo siva
-  Pepeljasto siva
-  Talijanski bagrem
-  Kanadski javor
-  Francuska bukva

Ostale informacije naći ćete na stranici 86.

BaseLine

Duradecor

Bijeli lak RAL 9016

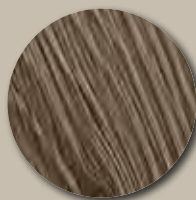

Duradecor struktura

Površina Duradecor Struktur stilski objedinjuje osjećaj pravog drveta i lakoću održavanja. Na decentan način predstavlja prirodni izgled drveta: u vratno krilo se utiskuje perforacija nalik drvetu pa se također može osjetiti dodir pravog drveta. Vrata koja se zatvaraju u ravnini i vrata s preklpom s četvrtastim rubovima s Duradecor strukturiranom površinom četkana bijele boje serijski su opremljena s kvalitetnom 4Protect zaštitom ruba.

Dekori

-  Sivi hrast*
-  Bijeli hrast*
-  Divlji hrast*
-  Sirovi hrast*
-  Tamni hrast
-  Španjolski hrast*
-  Orah
-  Četkani slani hrast
-  Četkani bor
-  Četkana bijela ■ **NOVO**

* i prožeto linijama

Ostale informacije naći ćete na stranici 87.

BaseLine

Duradecor struktura

Četkana bijela ■ **NOVO**







Lak

Drvena unutarnja vrata s lakiranom površinom djeluju elegantno i kvalitetno. Hörmann lakiranjem bijele Duradecor temeljne ploče nastaje jedinstvena površina, bez vidljivih fuga na rubovima kao i pun, briljantan učinak boje.

BaseLine

Čisto bijeli lak RAL 9010

Boje

-  Prometno bijela RAL 9016
-  Čisto bijela RAL 9010
-  Svijetlo siva RAL 7035
-  Antracit siva RAL 7016
-  RAL boja po izboru

Ostale informacije naći ćete na stranici 89.

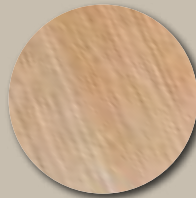

Drveni furnir

Prirodan, udoban, jedinstven – Hörmann furniri od pravog drva proizvode se od kvalitetnog plemenitog drva i pravi su unikatni.



BaseLine

Furnirano pravo drvo, hrast s mat lakom ■ **NOVO**

Furniri

-  Javor*
-  Bukva*
-  Jasen ■ **NOVO**
-  Limba ■ **NOVO**
-  Limba za premaz ■ **NEU**
-  Gorski hrast ■ **NOVO**
-  Američki hrast* ■ **NOVO**
-  Raszgranati hrast* ■ **NOVO**
-  Hrast s mat lakom ■ **NOVO**
-  Uljem premazan stari rast ■ **NOVO**
-  Američki orah* ■ **NOVO**
-  Bajcani hrast ■ **NOVO**
-  Macore ■ **NOVO**
-  Mahagoni ■ **NOVO**

* i prožeto linijama

Ostale informacije naći ćete na stranici 89.



Koncept 4 × 4: DesignLine Concepto

DesignLine Concepto savršen je izbor za moderan stil uređenja. Četiri moderne boje kombiniraju se s četiri elegantne površine.

Na taj način koncept prostora u svom domu možete oblikovati bez ograničenja i s puno stila. Otkrijte brojne mogućnosti kombiniranja.

Dodatne informacije naći ćete na stranici 88.



	Prometno bijela	Svijetlo siva	Antracit siva	Sivo smeđa ■ NOVO
Ultra mat				
Gloss				
Dojam četkane površine				
Lan ■ NOVO				





Na stranicama u nastavku prikazana su vrata u izvedbi s preklopom, s okovima, a vrata koja se zatvaraju u ravnini prepoznat ćete po ne vidljivim, skrivenim okovima.



Ultra mat

Posebno plemenita, svilenkasto mat Duradecor površina oduševit će Vas kako vizualno tako i na dodir. Ultra mat objedinjuje otpornost na otiske prstiju i zaprljanja sa do sada ne postignutim mat učinkom. Vrata s četvrtastim rubovima serijski su opremljena s kvalitetnom 4Protect zaštitom ruba.

Boje

-  Bijela
-  Svijetlo siva
-  Antracit siva
-  Sivo smeđa ■ **NOVO**

Ostale informacije naći ćete na stranici 88.

DesignLine Concepto



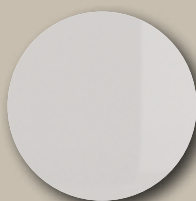

Ultra mat antracit siva



Gloss

Sjajno naglašavanje ili individualna nota – s vrlo sjajnom površinom uspjete oboje: površina kristalnog izgleda očarati će jedinstvenim sjajem. Učinak svjetlosti i odsjaja stvara nezamjenjiv ambijent.

Boje

-  Bijela
-  Svijetlo siva
-  Antracit siva
-  Sivo smeđa ■ **NOVO**

Ostale informacije naći ćete na stranici 88.

DesignLine Concepto

Sjajna svijetlo siva



DesignLine Concepto





Četkana bijela



Struktura kamena škrljevca

Doživite razliku sa svim osjetilima: češljana površina izrazito otporna na udarce, sa strukturiranom teksturom, prvi je izbor kada želite moderan i ujedno udoban dizajn. Kontrast svjetla i sjene na strukturi stvara vrlo ugodan i prirodan odsjaj. Ova je varijanta dostupna i za potpuno staklena vrata.

Boje

-  Bijela
-  Svijetlo siva
-  Antracit siva
-  Sivo smeđa ■ **NOVO**

Ostale informacije naći ćete na stranici 88.



DesignLine Concepto



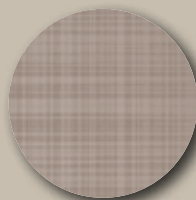

Siva smeđi lan, ručke i okovi kao black.edition ■ **NOVO**



Lan ■ **NOVO**

Nova Duradecor površina lan očarava svojom finom strukturom koju možete osjetiti. Ovaj dizajn posebno se dobro uklapa s tonovima drva i odgovara zahtjevnom, rustikalno-modernom stilu uređenja. Ova je površina ujedno robusna te joj je potrebno minimalno održavanje. Nova površina lan raspoloživa je i za staklena vrata.

Boje

-  Bijela
-  Svijetlo siva
-  Antracit siva
-  Sivo smeđa ■ **NOVO**

Ostale informacije naći ćete na stranici 88.

Za harmoničan
koncept prostora:
izgledom
ujednačena,
potpuno staklena
vrata



ConceptoGlass
■ NOVO
ESG, digitalni tisak
Bijeli lan

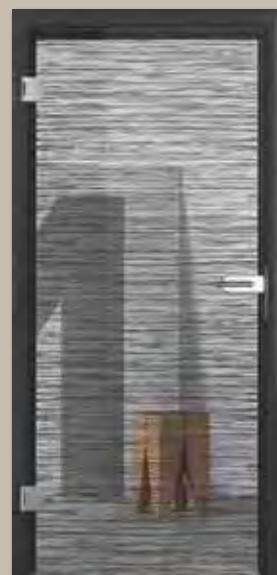

ConceptoGlass
■ NOVO
ESG, digitalni tisak
Četkana antracit siva

▼ **Drvena vrata DesignLine Concepto**, sivo smeđi lan, izvedba s preklopom





ConceptoGlass
■ NOVO
 ESG, digitalni tisak
 Četkana sivo smeđa
 površina



ConceptoGlass
■ NOVO
 ESG, digitalni tisak
 Češljana svjetlo siva
 površina



ConceptoGlass
■ NOVO
 ESG, digitalni tisak
 Četkana bijela

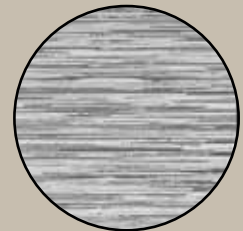

Češljana struktura za
 moderan i udoban dizajn
 doma



ConceptoGlass
■ NOVO
 ESG, digitalni tisak
 Svjetlo sivi lan



ConceptoGlass
■ NOVO
 ESG, digitalni tisak
 Antracit sivi lan



ConceptoGlass
■ NOVO
 ESG, digitalni tisak
 Sivo smeđi lan

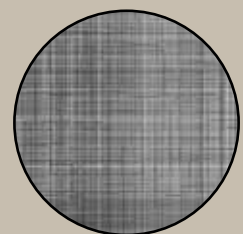

Zahtjevnii laneni dizajn
 savršeno se uklapa s
 drvenim vratima
 DesignLine Concepto lan

Klizna vrata – Kada ih ugraditi?

Tko se bavi uređenjem interijera mora odlučiti i o izboru vrata za svaku pojedinu prostoriju. Osim klasičnih unutarnjih vrata, čije se vratno krilo otvara prema unutrašnjoj strani prostorije, postoje i klizna vrata koja štede prostor, a koja se mogu postaviti na zid ili u zid.

Takva su vrata posebno praktična ako u sobi nema dovoljno prostora za klasična vrata. Klizna vrata su pravi čudotvorci i praktično su rješenje za skućeni dom.



Koje su prednosti kliznih vrata?

Kada diskretno ulaze u zid, s kliznim vratima dobivate više mjesta u svom domu. Klizna vrata dostupna su u različitom dizajnu te tako odgovaraju svakom stilu stanovanja.

Kakva krilna vrata postoje?

Postoje različite varijante kliznih vrata za unutarnje prostorije, koje možete izabrati u skladu sa svojim stanom. Na raspolaganju se dvije osnovne varijante, koje se sastoje ili od jednih vrata (jednokrilna) ili od dvoja vrata (dvokrilna). Obje varijante mogu sljedeće:

- ulaze u zid
- kreću se ispred zida

Kod tvrtke Hörmann serijski obuhvaća četkastu brtvu i brtvu u ulaznoj vodilici, koje štite od mirisa iz kuhinje, zvukova i propuha. Klizna se vrata po želji mogu opremiti bravom.

Mogućnosti postavljanja kliznih vrata

Mogućnost primjene kliznih vrata je neograničena. Mogu se savršeno primijeniti za fleksibilnu podjelu prostora, te unose strukturu i u duboke prostore. Klizna su vrata praktično rješenje i za male stanove, jer vratno krilo ne ulazi u prostor. Pomoću kliznih vrata se kod kuće primjerice jasno može odvojiti radni prostor za ured od dnevnog boravka. Tko bi rado imao otvorenu kuhinju, bez da se pri tome svi mirisi od kuhanja rasprše po stanu, ugradit će klizna vrata između kuhinje i blagovaonice. Tijekom kuhanja najbolje je vrata držati zatvorenima, a prilikom posluživanja se vrata mogu jednostavno otvoriti te tako koristite sve prednosti otvorene kuhinje. Klizna vrata ugrađena između dnevnog boravka, blagovaonice ili hodnika mogu štiti od propuha, a ako su staklena propuštaju dovoljno svjetlosti i time stvaraju ugodan osjećaj stanovanja.

Koje su mogućnosti dizajniranja kliznih vrata?

Hörmann u području kliznih vrata pruža **brojne mogućnosti dizajna** te ćete tako pronaći vrata, koja su najbolje usklađena s Vašim stilom stanovanja. Klizna su vrata dostupna kao **jednokrilna i dvokrilna** za sve motive vrata BaseLine, DesignLine i GlassLine.

Želite li bezvremensku eleganciju u tom vam slučaju preporučujemo **BaseLine** vrata. Ako pak polazete vrijednost na posebnu i individualnu opremu s aplikacijama od plemenitog čelika, udubljenim fugama ili kvalitetnim lakiranjem, onda Vam preporučujemo **DesignLine**. Klizna vrata **GlassLine** na posljetku Vašem domu pružaju više svjetlosti i otvorenosti.

Ostale informacije o Hörmann kliznim vratima naći ćete na stranicama 76 – 77.





Za individualno osmišljena vrata: DesignLine

S DesignLine ostvarujete svoje zamišljena vrata. Bilo da je riječ o plemenitim aplikacijama, udubljenim fugama ili modernim staklenim vratima, furniru od pravog drva ili o kvalitetnom lakiranju – DesignLine Vam nudi brojne motive vrata.

S DesignLine sobnim vratima i njihovim različitim izvedbama otkrijte vrata koja po pitanju dizajne, boje i dekora savršeno odgovaraju Vašem domu.

Ostale informacije o površinama, bojama i dekorima naći ćete na stranicama 86 – 89.





Duradecor glatki

Bijeli lak RAL 9016

Stripe

Decentan dizajn no ipak određenu posebnost daje motiv Stripe s izrađenim utorima. Vrata koja se zatvaraju u ravnini i vrata s preklopom s četvrtastim rubovima serijski su opremljena s kvalitetnom 4Protect zaštitom ruba.

Ostale informacije naći ćete na stranici 86.

Stripe 15

Duradecor

Bijeli lak RAL 9016

▼ **Drvena vrata DesignLine Groove 15**, prometno bijeli lak, RAL 9016, izvedba s utorima, potpuno staklena vrata DesignLine GrooveGlas 15









Groove

Motiv Groove plijeni poglede utorima urezanim u vratno krilo i kvalitetnim lakiranjem.

Boje

-  Prometno bijela RAL 9016
-  Čisto bijela RAL 9010
-  Svijetlo siva RAL 7035
-  Antracit siva RAL 7016
-  RAL boja po izboru

Ostale informacije naći ćete na stranici 89.

Groove 11

Lak
Prometno bijela RAL 9016



Groove 15

Lak
Prometno bijela RAL 9016



GrooveGlas 15/10
S mat površinama



GrooveGlas 15/5
S prozirnim linijama

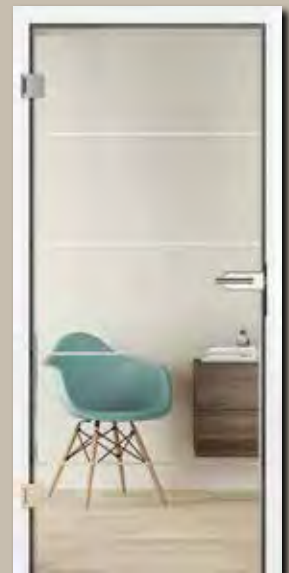

GrooveGlas 15/5
S mat linijama



Groove 3 ■ NOVO

Lak
Prometno bijela
RAL 9016



Groove 13

Lak
Prometno bijela
RAL 9016



GrooveGlas 13
S mat linijama



Groove 18 ■ NOVO

Lak
Prometno bijela
RAL 9016



Groove 16

Lak
Prometno bijela RAL 9016



GrooveGlas 16
S prozirnim rubovima



GrooveGlas 14
S mat linijama



GrooveGlas 14
S prozirnim linijama



Groove 14
Lak
Prometno bijela
RAL 9016







Groove 20
Lak
Prometno bijela
RAL 9016



GrooveGlas 20
S mat linijama

Lak

-  Prometno bijela
RAL 9016
-  Čisto bijela RAL 9010
-  Svijetlo siva RAL 7035
-  Antracit siva RAL 7016
-  RAL boja po izboru

Ostale informacije naći ćete
na stranici 89.



GrooveGlas 20
S prozirnim linijama



Groove 22 ■ NOVO
Lak
Prometno bijela
RAL 9016



Groove 19 ■ NOVO
Lak
Prometno bijela
RAL 9016



Groove 21
Lak
Prometno bijela
RAL 9016



Groove 23
Lak
Prometno bijela
RAL 9016



GrooveGlas 23
S mat linijom



Groove 29
Lak
Prometno bijela
RAL 9016



GrooveGlas 29
S mat linijama



GrooveGlas 29
S prozirnim linijama



GrooveGlas 29A
S mat linijom



GrooveGlas 23
S prozirnom linijom



Groove 27 ■ NOVO

Lak
Prometno bijela
RAL 9016



Groove 31

Lak
Prometno bijela
RAL 9016



Groove 34 ■ NOVO

Lak
Prometno bijela
RAL 9016



Groove 39 ■ NOVO

Lak
Prometno bijela
RAL 9016



Groove 44 ■ NOVO

Lak
Prometno bijela
RAL 9016



Groove 78 ■ NOVO





Lak
Prometno bijela
RAL 9016



GrooveGlas 78 ■ NOVO

S prozirnom linijom

Lak

-  Prometno bijela RAL 9016
-  Čisto bijela RAL 9010
-  Svijetlo siva RAL 7035
-  Antracit siva RAL 7016
-  RAL boja po izboru

Ostale informacije naći ćete na stranici 89.



Groove 49 ■ NOVO
Lak
Prometno bijela
RAL 9016



Groove 51 ■ NOVO
Lak
Prometno bijela
RAL 9016



GrooveGlas 51 ■ NOVO
S prozirnom linijom



Groove 53 ■ NOVO
Lak
Prometno bijela
RAL 9016



Groove 50 ■ NOVO
Lak
Prometno bijela
RAL 9016



Groove 55 ■ NOVO
Lak
Prometno bijela
RAL 9016



Groove 56 ■ NOVO
Lak
Prometno bijela
RAL 9016



Groove 54 ■ NOVO
Lak
Prometno bijela RAL 9016



Groove 85
Lak
Prometno bijela
RAL 9016



GrooveGlas 85 ■ NOVO
S prozirnim linijama



Groove 86 ■ NOVO
Lak
Prometno bijela
RAL 9016



Groove 87 ■ NOVO
Lak
Prometno bijela
RAL 9016



Groove 88 ■ NOVO
Lak
Prometno bijela
RAL 9016







Groove 89 ■ NOVO
Lak
Prometno bijela
RAL 9016



Groove 92 ■ NOVO
Lak
Prometno bijela
RAL 9016

Lak

-  Prometno bijela
RAL 9016
-  Čisto bijela RAL 9010
-  Svijetlo siva RAL 7035
-  Antracit siva RAL 7016
-  RAL boja po izboru

Ostale informacije naći ćete na stranici 89.



Steel

Ugrađene aplikacije nalik plemenitom čeliku kod motiva Steel čine moderan dizajn. Vrata koja se zatvaraju u ravnini i vrata s preklopom s četvrtastim rubovima s Duradecor površinom boje bijelog laka, svijetlo sivoj boji, Bütte bijeloj, Bütte svjetlo sivoj, jasen bijeloj i četkano bijeloj boji serijski su opremljena s kvalitetnom 4Protect zaštitom ruba.

Steel 14

Duradecor
Bijeli lak RAL 9016



Steel 16

Duradecor
Bijeli lak RAL 9016



Steel 20

Duradecor
Bijeli lak RAL 9016



Steel 23

Duradecor
Bijeli lak RAL 9016



Steel 27

Duradecor
Bijeli lak RAL 9016



Steel 29
Duradecor
Bijeli lak RAL 9016



Steel 37
Duradecor
Bijeli lak RAL 9016



Steel 38
Duradecor
Bijeli lak RAL 9016



Steel 39
Duradecor
Bijeli lak RAL 9016









Steel 44
Duradecor
Bijeli lak RAL 9016



Steel 78
Duradecor
Bijeli lak RAL 9016

Duradecor glatki





-  Bijeli lak RAL 9016
-  Svijetlo siva RAL 7035
-  Bijela
-  Svijetlo siva
-  Pepeljasto siva
-  Talijanski bagrem
-  Kanadski javor
-  Francuska bukva

Duradecor struktura





-  Sivi hrast*
-  Bijeli hrast*
-  Divlji hrast*
-  Sirovi hrast*
-  Tamni hrast
-  Španjolski hrast*
-  Orah
-  Četkani slani hrast
-  Četkani bor
-  Četkana bijela ■ **NOVO**

* i prožeto linijama

Duradecor ultra mat

-  Bijela
-  Svijetlo siva
-  Antracit siva
-  Sivo smeđa ■ **NOVO**

Lak

-  Prometno bijela RAL 9016
-  Čisto bijela RAL 9010
-  Svijetlo siva RAL 7035
-  Antracit siva RAL 7016
-  RAL boja po izboru

Ostale informacije naći ćete na stranicama od 86.



Plain

S upuštenim aplikacijama nalik plemenitom čeliku i aplikacijama u ravnini površine motiv Plain ima elegantan naglasak. Vrata koja se zatvaraju u ravnini i vrata s preklopom s četvrtastim rubovima s Duradecor površinom boje bijelog laka, svijetlo sivoj boji, Bütte bijeloj, Bütte svijetlo sivoj, jasen bijeloj i četkano bijeloj boji serijski su opremljena s kvalitetnom 4Protect zaštitom ruba.

Plain 14-7

Duradecor

Bijeli lak RAL 9016

▼ **Drvena vrata DesignLine**, Plain 29-7 Duradecor bijeli lak RAL 9016 i preklopna vrata BaseLine kao Duradecor s bijelim lakom RAL 9016





Plain 23-7
Duradecor
Bijeli lak RAL 9016



Plain 27-7
Duradecor
Bijeli lak RAL 9016











Plain 29-7
Duradecor
Bijeli lak RAL 9016



Plain 37-7
Duradecor
Bijeli lak RAL 9016

Duradecor glatki





-  Bijeli lak RAL 9016
-  Svijetlo siva RAL 7035
-  Bijela
-  Svijetlo siva
-  Pepeljasto siva
-  Talijanski bagrem
-  Kanadski javor
-  Francuska bukva

Duradecor struktura

-  Sivi hrast*
-  Bijeli hrast*
-  Divlji hrast*
-  Sirovi hrast*
-  Tamni hrast
-  Španjolski hrast*
-  Orah
-  Četkani slani hrast
-  Četkani bor
-  Četkana bijela ■ **NOVO**

* i prožeto linijama

Lak

-  Prometno bijela RAL 9016
-  Čisto bijela RAL 9010
-  Svijetlo siva RAL 7035
-  Antracit siva RAL 7016
-  RAL boja po izboru

Ostale informacije naći ćete na stranicama od 86.



Rail 2
Duradecor bijeli lak RAL 9016



Rail 1
Duradecor bijeli lak
RAL 9016



Rail









Kombinacija drva i stakla Rail preporučuje se kao idealna dopuna motivima drvenih vrata DesignLine.

Varijante stakla

-  Clear
-  Satinato
-  Sitotisak cijelom površinom
-  Wave
-  Raff
-  Jil
-  Lines
-  Gisa
-  Gropus prozirno
-  Gropus mat
-  GrooveGlas 15 prozirno
-  GrooveGlas 15 mat
-  GrooveGlas 29 prozirno
-  GrooveGlas 29 mat
-  Prozirno staklo
-  Mat staklo
-  Staklo s motivom

Daljnje informacije naći ćete na stranicama 54 – 65.

Duradecor glatki







-  Bijeli lak RAL 9016
-  Svijetlo siva RAL 7035
-  Bijela
-  Svijetlo siva
-  Pepeljasto siva
-  Talijanski bagrem
-  Kanadski javor
-  Francuska bukva

Duradecor struktura

-  Sivi hrast*
-  Bijeli hrast*
-  Divlji hrast*
-  Sirovi hrast*
-  Tamni hrast
-  Španjolski hrast*
-  Orah
-  Četkani slani hrast
-  Četkani bor
-  Četkana bijela ■ **NOVO**

* i prožeto linijama

Lak

-  Prometno bijela RAL 9016
-  Čisto bijela RAL 9010
-  Svijetlo siva RAL 7035
-  Antracit siva RAL 7016
-   RAL boja po izboru

Ostale informacije naći ćete na stranicama od 86.



Pure

Motiv Pure dojmít će Vas se upuštenim, ravnim staklenim elementom cijelom visinom vratnog krila.

Pure sredina

Duradecor bijeli lak RAL 9016



Pure strana okova









Duradecor
Bijeli lak RAL 9016



Pure strana brave

Duradecor
Bijeli lak RAL 9016

Duradecor glatki





-  Bijeli lak RAL 9016
-  Svijetlo siva RAL 7035
-  Bijela
-  Svijetlo siva
-  Pepeljasto siva
-  Talijanski bagrem
-  Kanadski javor
-  Francuska bukva

Duradecor struktura

-  Sivi hrast*
-  Bijeli hrast*
-  Divlji hrast*
-  Sirovi hrast*
-  Tamni hrast
-  Španjolski hrast*
-  Orah
-  Četkani slani hrast
-  Četkani bor
-  Četkana bijela ■ **NOVO**

* i prožeto linijama

Lak

-  Prometno bijela RAL 9016
-  Čisto bijela RAL 9010
-  Svijetlo siva RAL 7035
-  Antracit siva RAL 7016
-  RAL boja po izboru

Ostale informacije naći ćete na stranicama od 86.



Za ljubitelje klasike i elegancije: ClassicLine

Želite klasično, ali ipak moderno? Onda su Vas pravi izbor naši bezvremenski ClassicLine. Ovdje ćete pronaći savršena vrata za svoj stil ladanjske kuće.

Svi motivi ove serije oduševit će Vas ručno izrađenim stolarskim detaljima: posebno kvalitetna vrata Georgia sa svojim umetnutim profilnim letvicama. Motivi Carolina s izrađenom teksturom, novi Montana motivi s kvalitetno dorađenim dovratnikom, novi motivi Kontura s izrađenim profilima te vrata Virginia sa svojim elegantnim dizajnom.

I za ClassicLine vrijedi sljedeće: ovisno o izvedbi vrata možete birati glatke Duradecor površine, Duradecor sa strukturom, lakom ili dekorom, kao i brojne boje i dekore.

Ostale informacije naći ćete na stranicama 86 – 89.

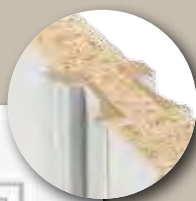



Georgia

U najboljoj stolarskoj tradiciji kvalitetna letvica profila motiva vrata Georgia polaže se u ulegnuće vratnog krila te tim motivima daje izrazito elegantan izgled.

Georgia 1

Duradecor bijeli lak RAL 9016

Duradecor glatki

-  Bijeli lak RAL 9016
-  Pepeljasto siva
-  Talijanski bagrem

Duradecor struktura

-  Sivi hrast*
-  Bijeli hrast*
-  Divlji hrast*
-  Sirovi hrast*
-  Tamni hrast
-  Četkani slani hrast
-  Četkani bor

* i prožeto linijama

Lak

-  Prometno bijela RAL 9016

Ostale informacije naći ćete na stranicama od 86.



Georgia 2

S otvorima za svjetlo
Duradecor
Bijeli lak RAL 9016



Georgia 3

Duradecor
Bijeli lak RAL 9016



Georgia 4

S otvorima za svjetlo
Duradecor
Bijeli lak RAL 9016



Georgia 5

Duradecor
Bijeli lak RAL 9016

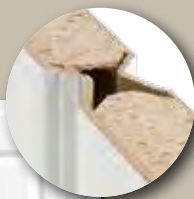

Carolina

Kazetni okvir motiva vrata Carolina nastaje izrađenim profilima u vratnom krilu. Zahvaljujući kvalitetnom lakiranju možete se veseliti ravnomjerno obojenoj, briljantnoj površini.

Lak



Prometno bijela RAL 9016

Ostale informacije naći ćete na stranici 89.

Carolina 5

Lak

Prometno bijela RAL 9016



Carolina 1

S otvorom za svjetlo

LA 2 Lugano

Lak

Prometno bijela

RAL 9016



Carolina 2

Lak

Prometno bijela

RAL 9016



Carolina 4

S otvorom za svjetlo LA s

letvicama 2 / 3

Lak

Prometno bijela

RAL 9016



Carolina 5

S otvorom za svjetlo LA 3

Lak

Prometno bijela

RAL 9016



Montana ■ NOVO

Kod motiva Montana obrađeni okviri naglašavaju eleganciju. Reducirana forma prikladna je kako za klasično tako i za moderno uređenje doma.

Lak

 Prometno bijela RAL 9016

Ostale informacije naći ćete na stranici 89.

Montana 4

S otvorima za svjetlo

Lak

Prometno bijela RAL 9016



Montana 1

S otvorima za svjetlo

Lak

Prometno bijela
RAL 9016



Montana 2

Lak

Prometno bijela
RAL 9016



Montana 3

Lak

Prometno bijela
RAL 9016



Montana 5

Lak

Prometno bijela
RAL 9016



▲ Drvena vrata ClassicLine Montana 4, lak prometno bijele boje RAL 9016, izvedba s preklapanjem vrata na dovratnik



Montana 6
S otvorima za svjetlo
Lak
Prometno bijela
RAL 9016



Montana 7
Lak
Prometno bijela
RAL 9016



Montana 7
S otvorima za svjetlo
Lak
Prometno bijela
RAL 9016







Montana 8
Lak
Prometno bijela
RAL 9016



Kontura ■ NOVO

Motivi vrata Kontura serije poseban šarm dobivaju frezanim profilima u kombinaciji s naglašenom V fugom.

Lak

-  Prometno bijela RAL 9016
-  Čisto bijela RAL 9010
-  Svijetlo siva RAL 7035
-  Antracit siva RAL 7016
-  RAL boja po izboru

Ostale informacije naći ćete na stranici 89.

Kontura 2

Lak
Prometno bijela RAL 9016

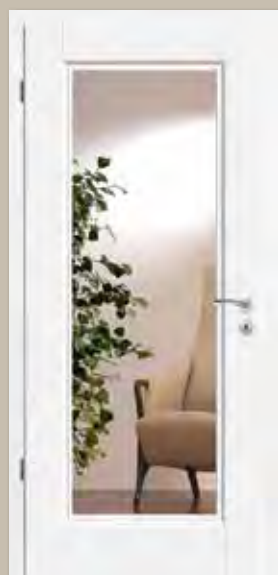

Kontura 1
S otvorom za svjetlo
LA 2 1
Lak
Prometno bijela RAL 9016



Kontura 3
S otvorom za svjetlo LA
Lak
Prometno bijela
RAL 9016



Kontura 4
Letvica 1/3
Lak
Prometno bijela
RAL 9016



Kontura 5
Lak
Prometno bijela
RAL 9016



Kontura 6
S otvorom za svjetlo LA 2
Lak
Prometno bijela
RAL 9016



Kontura 7
Lak
Prometno bijela
RAL 9016



Kontura 12
Lak
Prometno bijela
RAL 9016



Kontura 12
S otvorom za svjetlo LA
Lak
Prometno bijela
RAL 9016

▼ **Drvena vrata ClassicLine Kontura 2**, lak prometno bijele boje RAL 9016





Virginia

Klasična izvedba vrata sastoji se od konstrukcije okvira sa do 3 plohe. Polja po izboru mogu biti ostakljena ili ispunjena drvenom pločom.

Dekor

Bijeli lak nalik RAL 9016

Virginia 3

Dekor bijeli lak

Sa 3 ostakljena polja



Virginia 1

Dekor bijeli lak



Virginia 1

Dekor bijeli lak

S 1 ostakljenim poljem



Virginia 2

Dekor bijeli lak



Virginia 2

Dekor bijeli lak

S 1 ostakljenim poljem



▲ **Drvena vrata ClassicLine Virginia 3**, Dekor bijeli lak, izvedba s preklapanjem vrata na dovratnik

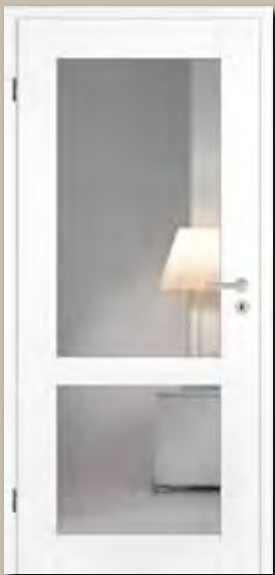

Virginia 2
Dekor bijeli lak
Sa 2 ostakljena polja



Virginia 3
Dekor bijeli lak



Virginia 3
Dekor bijeli lak
S 1 ostakljenim poljem



Virginia 3
Dekor bijeli lak
Sa 2 ostakljena polja



Više svjetla u Vašem domu: GlassLine

Vrata GlassLine pružaju brojne jasne prednosti: staklena su vrata lijepa i šik, Vašem domu daju dojam otvorenosti, a svakoj prostoriji sasvim poseban šarm.

Spoznajte koja izvedba najbolje odgovara Vašem domu i birajte između krilnih vrata, potpuno staklenih vrata s drvenim okvirom ili kliznih vrata.

Posebne i vrlo individualne naglaske stavit ćete s novim toniranim motivima, koje Vašim staklenim vratima daju markantnu nijansu.



Pjeskareno

Kada cijenite individualnost: tehnikom pjeskarenja u staklenoj se površini ocrtavaju fini motivi. Mat površina s nano slojem jamči malo otisaka prstiju.



Aldo
ESG, pjeskareno, s prozirnim prugama

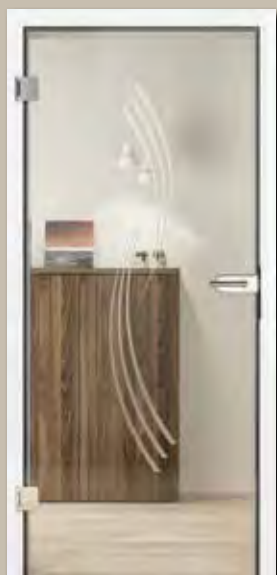

Amra ■ NOVO
ESG, pjeskareno, s matiranim prugama



Bamante
ESG, pjeskareno, s prozirnim površinama i matiranim prugama



City ■ NOVO
ESG, pjeskareno, s matiranim površinama



Corbus
ESG, pjeskareno, s matiranim pravokutnicima



Corbus
ESG, pjeskareno, s prozirnim pravokutnicima



Cube ■ NOVO
ESG, pjeskareno, s matiranim površinama



Graphic
ESG, pjeskareno, s matiranim prugama



Graphic ■ NOVO
ESG, pjeskareno, s prozirnim prugama



Jada
ESG, pjeskareno, s prozirnim i matiranim prugama



Jil
ESG, pjeskareno, s matiranim prugama



Jil ■ NOVO
ESG, pjeskareno, s prozirnim prugama



Liko
ESG, pjeskareno, s matiranim prugama



Liko ■ NOVO
ESG, pjeskareno, s prozirnim prugama



Lilu ■ NOVO
ESG, pjeskareno, s matiranim prugama



Luba ■ NOVO
ESG, pjeskareno, s
matiranim prugama

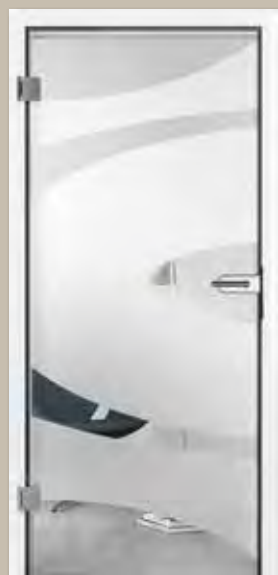

Meda ■ NOVO
ESG, pjeskareno, s
prozirnim prugama



Memory ■ NOVO
ESG, pjeskareno, s
prozirnim kvadratima



Memory ■ NOVO
ESG, pjeskareno, s
matiranim kvadratima

▼ Potpuno staklena vrata GlassLine Raff





Milton ■ NOVO
ESG, pjeskareno, s
matiranim prugama



Milton ■ NOVO
ESG, pjeskareno, s
prozirnim prugama



Nubia
ESG, pjeskareno,
matirane površine prelaze
u prozirne površine



Pinta ■ NOVO
ESG, pjeskareno, s
matiranim površinama



Privat
ESG, pjeskareno, motiv
po želji, slika: s prozirnim
natpisom



Raff
ESG, pjeskareno, s
prozirnim motivom



Raff ■ NOVO
ESG, pjeskareno, s
matiranim motivom
(opcija sa sitotiskom)

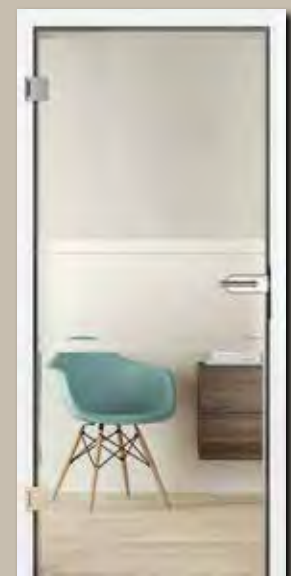

Saha
ESG, pjeskareno, s
matiranim prugama



Wave
ESG, pjeskareno, s
prozirnim motivom (opcija
sa sitotiskom)



Wave ■ NOVO
ESG, pjeskareno, s
matiranim motivom



Wildlife
ESG, pjeskareno, s
matiranim prugama



Wildlife ■ NOVO
ESG, pjeskareno, s
prozirnim prugama

▼ Potpuno staklena vrata GlassLine Satinato kao sustav kliznih vrata Rotan





Laserska tehnika

Ovakva obrada stakla oduševit će Vas finim detaljima i sjenjčanjem. Dojam dubine ostavlja fascinantno utisak, koji se dodatno pojačava sjajem potpuno staklenih vrata.



Agesa
ESG, tehnika laserom, s mat prugama



Aino ■ NOVO
ESG, tehnika laserom, s mat prugama



Lines
ESG, tehnika laserom, s mat prugama



Lito
ESG, tehnika laserom, s mat teksturom



Sitotisak

Ovdje se dizajn sjedinjuje s plemenitom površinom: na ogrebotine izrazito otporna površina jednostavna je za održavanje i neosjetljiva na prašinu.



Batista ■ NOVO
ESG, sitotisak, s mat i prozirnim prugama



Lou ■ NOVO
ESG, sitotisak, s mat krugovima



Rika
ESG, sitotisak, s mat pravokutnicima



Sitotisak cijelom površinom ■ NOVO
ESG, sitotisak, mat cijelom površinom



Yoko ■ NOVO
ESG, sitotisak, s prozirnim prugama



Gravura

Gravura na staklenim vratima nastaje finom V fugom. Ovisno od prozirnosti koju želite, upotrebljava se prozirno odnosno satinirano staklo. Gravura će vas oduševiti posebnim uzorcima, opipljivošću i neuobičajenom igrom svjetlosti, koji nastaje djelovanjem prizme.



Coco
ESG, Satinato s gravurom



Gropus
ESG, Satinato s gravurom

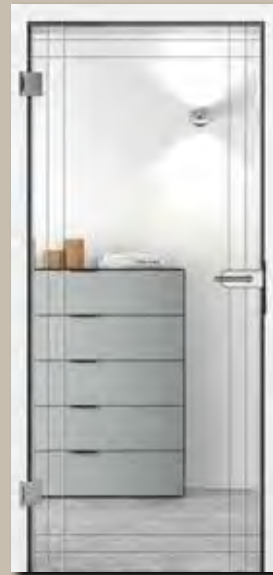

Velita ■ NOVO
ESG, prozirno s gravurom



Coco
ESG, prozirno s gravurom



Gropus ■ NOVO
ESG, prozirno s gravurom



Velita ■ NOVO
ESG, Satinato s gravurom



Clear ■ NOVO
VSG, unutra umetnuta
prozirna folija



Black ■ NOVO
VSG, unutra umetnuta
folija u boji



Satinato izgled ■ NOVO
VSG, unutra umetnuta
mat folija



White ■ NOVO
VSG, unutra umetnuta
folija u boji



Clear ■ NOVO
ESG

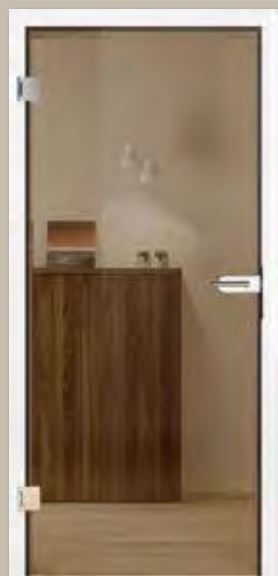

Clear bronze ■ NOVO
ESG, tonirano



Clear grey ■ NOVO
ESG, tonirano



Dark Grey ■ NOVO
ESG, tonirano

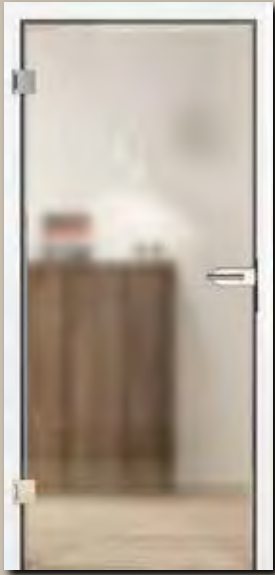

Mastercarré ■ NOVO
ESG, Mastercarré



Satinato ■ NOVO
ESG, Satinato



Staklo Clear

Staklena vrata ovom vrstom stakla stvaraju decentan i interesantan kontrast. „Zelenkasti odsjaj“ nastaje zbog prisutnosti željeznog oksida u staklu. Staklena vrata i interijer se, zbog toga, prikazuju u „drugačijem svjetlu“.



Mirastar ■ NOVO
ESG, s obje strane izgled ogledala i prozirno



Staklo Clear White

Staklena vrata u izvedbi Clear white daju blistavu bijeli odsjaj. Dizajn u optici Santinato dolazi kod motiva za ostakljenja posebno do izražaja, a naša preporuka je Clear White za izvedbe s VSG i unutra položene bijele folije.



Inteligentne funkcije za veću sigurnost i komfor

Vaša Hörmann ulazna vrata možete opremiti s brojnim dodatnim funkcijama: za veliki broj motiva dostupna je zaštita od buke, zaštita od požara i protudimna svojstva te dodatne sigurnosne funkcije poput špijunke ili elektromotorne brave.

Uz inovativna rješenja poput daljinskog upravljanja bravom, SmartKey, povećavate svakodnevni komfor življenja: bravu svojih vrata otvarajte jednostavnim pritiskom na tipku daljinskog upravljača, bežičnog unutarnjeg tastera, BiSecur aplikacije na svojem pametnom telefonu ili izravno putem senzorskog polja na SmartKey tipkovnici.

Za osobe s poteškoćama u kretanju ili one koje žele još više komfora idealan je pogon vrata PortaMatic. Automatsko otvaranje i zatvaranje vrata s daljinskim upravljačem ili tasterom znači povećanu kvalitetu života – za što je zaslužan Hörmann.

Hörmann ulazna vrata stana i vrata za zaštitu od požara nude više

Dakle više funkcija od konvencionalnih vrata. Opremite svoja Hörmann vrata, u skladu sa svojim potrebama, važnim dodatnim funkcijama poput zaštite od požara, buke ili nekim drugim sigurnosnim elementima. Hörmann nudi i vrata za mokre i vlažne prostorije, harmonika vrata i mimokretna i prolazna vrata.



Klimatski razred 3

Vrata ove klase raspolažu posebnim vratnim krilom, koje izjednačava temperaturu i razliku u vlazi između prostorija za različitih namjene u domu, poput primjerice hladnog podruma i grijanog hodnika. Učinak: ušteda energije i zaštita od presporog kretanja vrata.



Zvučna izolacija

Vrata sa zaštitom od buke postavljaju se u stanovima ili radnim prostorima gdje može doći do nastanka velike buke. Odlučujući je spoj između vrata i dovratnika. On je značajna komponenta za osiguravanje željene zaštite od buke.

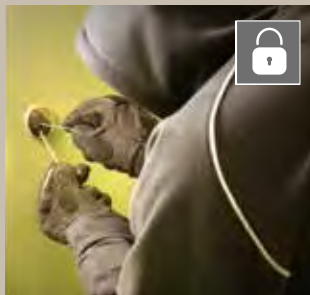

Sigurnost







Zahvaljujući prilagođenim posebnim funkcijama ujedno se može smanjiti rizik od mogućih provala. Hörmann preporučuje za ulazna vrata stana klasu otpornosti RC 2 ili još bolje RC 3.



Zaštita od požara

Zaštita od požara može spasiti živote! Opremljena vrata mogu spriječiti prodor vanjskog plamena (u trajanju od najmanje 30 odnosno 90 minuta), ali i prodiranje opasnih plinova od sagorijevanja. Protupožarni i protudimni elementi isporučuju se kao kompletan element uključujući dovratnik i sve popratne okove.

Ulazna vrata za stan









Funkcije	WAT sustav 1*	WAT sustav 2*	WAT sustav 3*
Debljina vrata	40 mm	46 mm	52 mm
Maks. dimenzija	2110 × 985 mm	2235 × 1110 mm	2485 × 1235 mm**
 Klimatski razred 3	●	●	●
 Klasa zaštite od buke 1	●		
 Klasa zaštite od buke 2		●	
 Klasa zaštite od buke 3		●	●
 Zaštitna oprema RC2			●
 Zaštitna oprema RC3			●

* Nije moguće kod: Groove Lack, Steel Concepto / Lack, Plain Duradecor / Lack

** kod RC 3: 2235 × 1110 mm

● = standardna oprema

Protupožarna vrata

Funkcije	Dimonepropusna vrata*	T30 protupožarna vrata**	T90 protupožarna vrata***
Debljina vrata	40 mm	50 mm	70 mm
Maks. dimenzija	2110 × 985 mm	2235 × 1235 mm	2485 × 1235 mm
 T30 protupožarna		●	
 T90 Vatrootpornost			●
 Zaštita od dima	●	○	○
 Klimatski razred 2		●	●
 Klimatski razred 3		○	○
 Klasa zaštite od buke 1		○	○
 Klasa zaštite od buke 2	●	○	○
 Zaštitna oprema RC2		○	○
 Zaštitna oprema RC3			○

* Nije moguće za: Concepto, Stripe, Groove Lack, Steel Concepto / Lack, Plain Duradecor / Lack

** Nije moguće za: Stripe, Steel Concepto

*** Nije moguće za: Concepto, Steel Concepto / Lack, Stripe, Groove Lack, Plain Duradecor / Lack

● = standardna oprema

○ = opcionalna oprema



Špijunka

Još jedan dodatak na sigurnost: s špijunkom možete u svakom trenutku vidjeti tko Vam stoji ispred ulaznih vrata bez da ih morate otvarati.



E-otvarač

Električna brava omogućava jednostavno otvaranje vrata prekidačem iz stana.



Elektromotorna brava

Tako ćete na vrlo praktičan način automatski, udobno i sigurno zaključati vrata stana.



Sigurnosni okov ES 2

opcionalno sa zaštitnom opremom RC 2



Zatvarač vrata sa šipkom

Serijski za jednokrlna vrata s protupožarnom zaštitom



Zatvarač vrata s kliznom vodilicom

Serijski za dvokrlna vrata s protupožarnom zaštitom, opcionalno za jednokrlna vrata s protupožarnom zaštitom

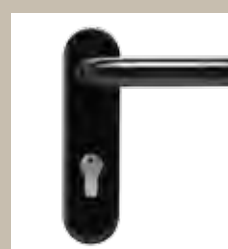

Ručka za protupožarna vrata

(Profilni cilindar nije uključen u obim isporuke)

Bežična brava za vrata SmartKey

Bravu svojih vrata otvarajte jednostavnim pritiskom na tipku daljinskog upravljača, bežičnog unutarnjeg tastera, BiSecur aplikacije na svojem pametnom telefonu* ili izravno putem senzorskog polja na SmartKey tipkovnici. Na taj način ne morate odlagati svoje stvari kako biste otvorili vrata stana ili kuće. Na ovaj način ćete puno jednostavnije ući u kuću ili stan s rolatorom, invalidskim kolicima ili s dječjim kolicima, jer vrata možete otvoriti već iz daljine. Zaključavanje se vrši pritiskom na tipku ili automatski nakon određenog vremena. Tako je brava vrata sigurno zaključana i pruža zaštitu od provale.



SmartKey sustav daljinskog upravljanja vratima u bijeloj ili srebrnoj boji uključuje daljinski upravljač HSE 4 SK BS s označenim tasterima.





Vrlo praktično upravljanje

- Zaključavanje odn. otključavanje brave vrata
- Otvaranje vrata (uskočnik se povlači u trajanju programiranog vremena i vrata se mogu jednostavno otvoriti) **1**
- Upravljanje putem daljinskog upravljača, bežičnog unutarnjeg tastera ili BiSecur aplikacije **2**
- Automatsko praktično zaključavanje, po izboru 30, 60 ili 120 sek. ili s vremenskim pomakom nakon pritiska na tipku **3**
- U svakom je trenutku moguće** ručno otvaranje i zatvaranje u slučaju opasnosti (izvana s uobičajenim ključem, iznutra kotačem)

Sigurna provjera

- Zvučna / optička povratna informacija na motoru, kad se brava vrata zaključava / otključava ili otvara
- Provjera na opcionalnom daljinskom upravljaču HS 5 BS ili bežičnom unutarnjem tasteru FIT 5, jesu li vrata zaključana ili otključana – više po noći ne morate provjeravati jesu li Vaša ulazna vrata zaključana. **4**
- BiSecur bežični sustav s ekstremno sigurnim postupkom zaključavanja
- Stanje mirovanja s isključenom bežičnom funkcijom

Savršeno za naknadno opremanje

- Fleksibilna ugradnja spajanjem, lijepljenjem ili pričvršćenjem vijcima na unutarnju stranu vrata
- Bez oštećenja na vratima ili dovratniku (idealno za stanove za najam i za turizam)
- Jednostavno dodavanje na ključ***
- Bežična instalacija zahvaljujući pogonu na baterije (trajanje oko godine dana*** kod 8 ciklusa dnevno)



Brava je zaključana



Brava vrata je otključana

* BiSecur Gateway je dodatno potreban

** Potreban je cilindar s funkcijom za slučaj opasnosti

*** Neophodan je produžetak cilindra od 7 – 12 mm, glava ključa mora se skratiti na dužinu od 4 – 7 mm

**** Ovisno o pokretljivosti vrata odnosno brave, kao i o umetnutim baterijama!

Otvaranje i zatvaranje vrata bez muke

S Hörmann motorom PortaMatic svoja drvena i čelična unutarnja vrata sasvim jednostavno otvarate i zatvarate automatski daljinskim upravljačem ili tipkom. Ova će Vam tehnika olakšati svakodnevnicu bez obzira na okolnosti. Motor za vrata PortaMatic nema samo brojne funkcije i mogućnosti podešavanja, već troši i vrlo malo struje. PortaMatic je ujedno do 25 % povoljniji od ostalih, uspoređenih, pogona za vrata te podliježe 100 % osiguranju.

Informacije o dodatnim mogućnostima pronaći ćete na stranicama <http://www.hoermann.de/portamatic/zuschuss>

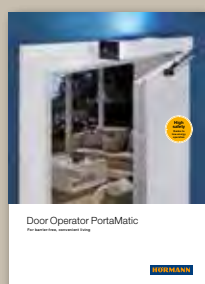

Daljnje informacije pronaći ćete u brošuri za pogon PortaMatic.



Stanovanje prilagođeno starosnoj dobi

Želite i dalje biti pokretni unatoč tjelesnim ograničenjima? PortaMatic motor za unutarnja vrata vraćaju Vam dio kvalitete života, tako da se unutar svog doma možete kretati bez pomoći drugih ljudi.

Udoban život

Prenesite pune pladnjeve, teške sanduke pića ili kupljene namirnice u vrećicama kroz prostore bez puno muke. Uvijek ćete poželjeti imati ovaj komfor.

Raditi bez prepreka

Rad bez prepreka danas ima veliku vrijednost i predviđa mu se u budućnosti veći značaj. PortaMatic motor vrata može se vrlo jednostavno integrirati na svoje radno mjesto, u područja koja nisu javna te tako omogućiti veći udobnost pri radu.

Higijensko upravljanje vratima

U uredskim zgradama je velika mogućnost zaraze virusima i bakterijama na vratima sanitarnih čvorova. PortaMatic motori vrata u kombinaciji s bez kontaktnim prekidačem pouzdano Vas štiti od virusa i bakterija te Vam daje osjećaj sigurnosti.



Robusni čelični dovratnik VarioFix

Sva naša ulazna vrata stana dostupna su, osim u serijskoj izvedbi s drvenim dovratnikom i u varijanti s čeličnim dovratnikom VarioFix. On je idealno rješenje za sva ulazna vrata stana i unutarnja vrata različitih područja življenja ili za objekte, na koje su postavljeni visoki zahtjevi na otpornost i dugotrajnost.

VarioFix dovratnik s protuokvirom, s obje strane 55 mm, savršeno odgovara drvenom dovratniku. Tako možete vrata s različitim dovratnicima postaviti u jednu prostoriju odnosno kuću.

Tolerancije zida do 20 mm nisu nikakav problem za VarioFix čelični dovratnik. Prilagodljiv ukrasni žljebić sasvim jednostavno izjednačava različite debljine zidova prilikom renoviranja ili novogradnje.

VarioFix dovratnik dostupan je u bijeloj RAL 9016 boji usklađen s našim vratnim krilima u Duradecor izvedbi bijelog laka te lakirano bijelom bojom ili drugim RAL bojama prema izboru.



Obostrana dubina dovratnika od 55 mm VarioFix dovratnika (slika lijevo) savršeno je usklađena s drvenim dovratnicima (slika desno).



VarioFix dovratnik je posebno robustan i može izdržati „sudare“ s dječjim automobilima ili usisavačima.



VarioFix dovratnik prikladan je za ulazna vrata stana uključujući RC 2 sigurnosnu opremu i zaštitu od buke.

VarioFix: čelični dovratnik s brojnim prednostima

Otporan na oštećenja **1**

Robusni VarioFix dovratnik može izdržati koji sudar s dječjim vozilima ili usisavačem. Kod drvenih dovratnika u takvim slučajevima može doći do oštećenja ruba.



Neosjetljiv na vodu od pranja **2**

U prostorijama s pločicama je VarioFix dovratnik optimalno rješenje. Zahvaljujući kvalitetnom cinčanju, dovratnik neće biti oštećen u slučaju doticaja s vodom od pranja. Kod drvenih dovratnika postoji opasnost od listanja donjeg ruba dovratnika te se onda mora izvući, ne tako lijepa, silikonska fuga.



Nevidljiv kosi spoj **3**

Plastificirani VarioFix čelični dovratnik u kutevima je kvalitetno zavaren i obrađen ravno, tako da, za razliku od drvenih dovratnika, nisu vidljivi kosi rezovi u kutovima.

Jednakomjerni razmak kod vrata koja se zatvaraju u ravnini **4**

Zbog stabilne čelične konstrukcije, VarioFix dovratnik se nakon ugradnje više ne može iskriviti. To jamči ujednačen razmak između vrata koja se naslanjaju pri čemu se dobije ugodan i elegantan izgled vrata.

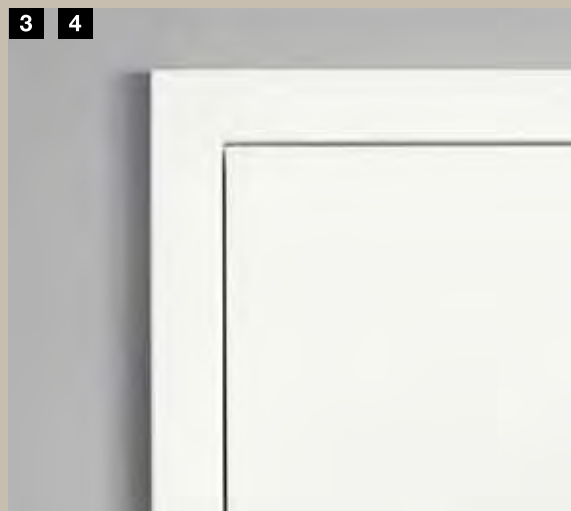

Naš prostorni čudotvorac: klizna vrata

Klizna vrata otvaraju Vam nove mogućnosti za optimalno iskorištavanje Vaših prostorija. Hörmann nudi, za svaku situaciju doma, jednokrilna i dvokrilna rješenja kliznih vrata. Mi nudimo za sve motive vrata iz linije BaseLine i DesignLine te GlassLine opciju kliznih vrata.



Sustav kliznih vrata u dovratniku

Kod ugradnje ispred zida vratno krilo na integrirani vodilicama klizi u kutiju za klizna vrata. Kod ugradnje u zid vodilice se montiraju na mjestu postavljanja u zid. U tom slučaju nije potrebna kutija za klizna vrata. Otvor zida prekriva dovratnik.



Klizna vrata ugrađena ispred zida sa dovratnicima tipa C optimalnu zaštitu od mirisa, buke i propuha pružaju četkom postavljenom na vratno krilo (slika lijevo) i opcionalnom brtvom postavljenom u ulaz u dovratnik (slika desno) – tako ćete se u svoja četiri zida osjećati još udobnije.



Sustav kliznih vrata Slide Compact

U ovom sistemu vratna krila klize po profilu vodilica. Profil u boji plemenitog čelika može se montirati na zid ili na strop. Za težinu vratnog krila od 60 kg je sustav SlideCompact opremljen sa SafeClose za nježno zatvaranje vratnog krila.



Sustav kliznih vrata Rotan

Kod ovog sustava kliznih vrata u industrijskom stilu, sva vratna krila montirana su na konzolama koje s kotačićima klize o vodilicama. Prečka od plemenitog čelika montira se na zid.



Sustav kliznih vrata Slide Compact s dodatnim vertikalnim okovima za jednokrlna vrata, postavljen ispred zida ■ **NOVO**



Profil je dostupan i u crnoj mat boji, kao i ručke. Ostale informacije naći ćete na stranici 84.



Cooler izgled, elegantna funkcija: kod sustava kliznih vrata Rotan konzole na kotačićima klize po prečki.

Prorez ostakljenja

S našom ponudom proreza ostakljenja napravite od Vaših željenih motiva svoja individualna vrata. Svijetli prorezi dostupni su Vam u ostakljenju prema Vašem odabiru.

Bočni elementi i nadsvjetla

Bočni elementi i nadsvjetla obasipaju Vaše prostorije sa svjetlom i zaslužni su za poseban štih. Bočni dijelovi optički ističu elemente vrata, a nadsvjetla naglašavaju visinu prostorije. Gornje maske naglašavaju visinu elemenata.



Prorez ostakljenja

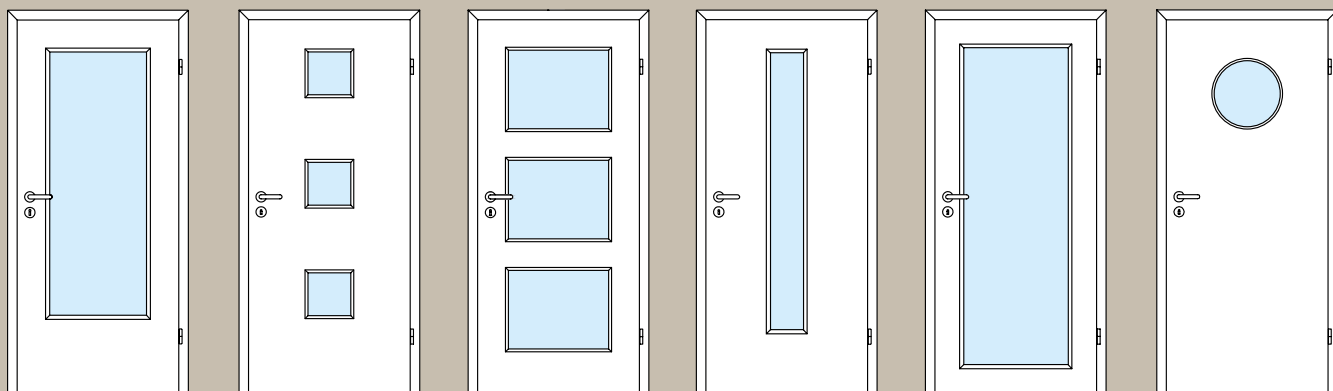

DIN

LA 10

LA 11

LA 24 u sredini

LA 27

okruglo staklo

Svi motivi vrata DesignLine Georgia, Vermont i Carolina dostupni su sa ostakljenjem u gornjim poljima kazeta.

Bočni elementi

(visina nadvoja)

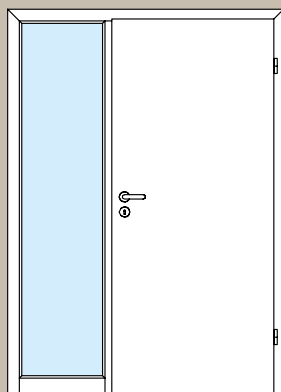

Jednoskrilna, 1 bočni element

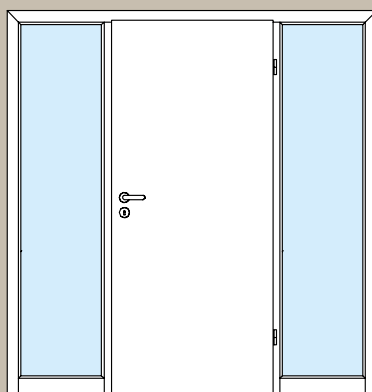

Jednokrilna, 2 bočna elementa

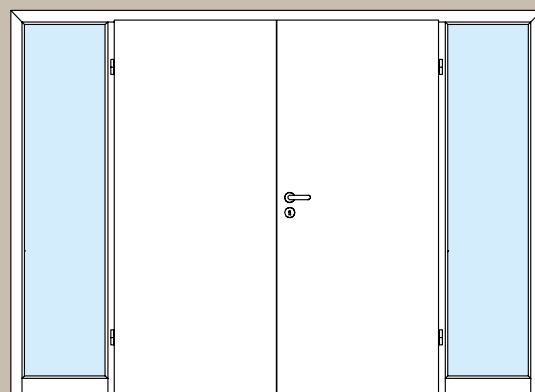

Dvokrilna, 2 bočna elementa

Nadsvjetla

(visina stana)

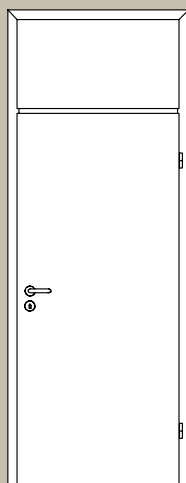

Jednokrilna, 1 gornja maska, alternativno i s nadsvjetlom

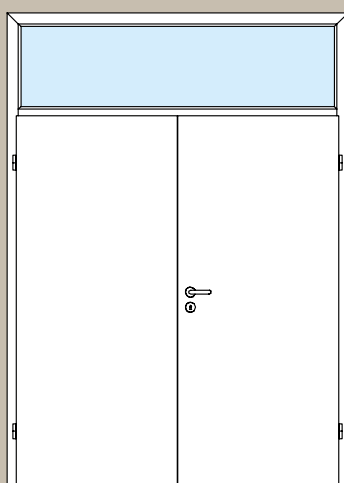

Dvokrilna, 1 nadsvjetlo

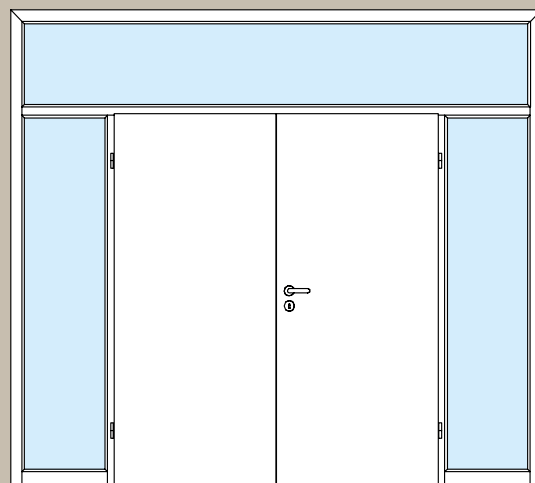

Dvokrilna, 2 bočna elementa, 1 nadsvjetlo

Individualne želje nadohvat ruke

Mi ćemo biti zadovoljni tek kada ćete Vi pronaći svoja vrata iz snova koja Vam odgovaraju u svakom detalju. Zbog toga možete individualno odabrati iz široke palete Hörmann proizvoda Vašu ručku i okove: mnogobrojne garniture **ručki za drvena vrata** iz našeg programa pronaći ćete i u **Planar varijanti** za posebno elegantan izgled vrata. Za ljubitelje dizajna preporučujemo ručke i okove **u novom crnom izdanju black edition**.

Opsežan sortiment zaokružuju posebni okovi za **staklena vrata** i **klizna vrata**.



Za posebno elegantan izgled vrata opcionalno, za svaku ručku, postoji i Planar varijanta bez provrta za ključanicu.

Garnitura ručki za drvena vrata



Ala okrugla rozeta, mat plemeniti čelik



Apart okrugla rozeta, matirani nehradajući čelik



Arundo okrugla rozeta, matirani plemeniti čelik



Basica 2 okrugla rozeta, matirani plemeniti čelik



Basica 3 okrugla rozeta, matirani nehradajući čelik



Contra okrugla rozeta, matirani plemeniti čelik



Dee okrugla rozeta, matirani plemeniti čelik

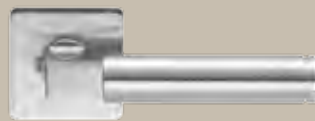

Dee četvrtasta rozeta, matirani plemeniti čelik



Graphica četvrtasta rozeta, polirani plemeniti čelik



Graphica četvrtasta plosnata rozeta, matirani plemeniti čelik



Indra okrugla rozeta, polirani matirani plemeniti čelik



Indra okrugla plosnata rozeta, polirani matirani plemeniti čelik



Karee četvrtasta rozeta, matirani plemeniti čelik



Lilet okrugla rozeta, polirani plemeniti čelik, porculan bijela drška



Linea okrugle rozeta, matirani plemeniti čelik

Garnitura ručki za drvena vrata



Linea okrugla plosnata rozeta, matirani plemeniti čelik



Linea okrugla plosnata rozeta, polirani plemeniti čelik



Linea black.edition, okrugla rozeta, matirana crna boja ■ NOVO



Linea četvrtasta plosnata rozeta, matirani plemeniti čelik



Luba okrugla rozeta, matirani plemeniti čelik



Linea black.edition, okrugla plosnata rozeta, matirana crna boja ■ NOVO



Quadriga četvrtasta rozeta, matirani plemeniti čelik



Selecta okrugla rozeta, matirani polirani plemeniti čelik



Karee black.edition, četvrtasta rozeta, matirana crna boja ■ NOVO



Senso okrugla rozeta, matirani plemeniti čelik



Tento okrugla rozeta, matirani plemeniti čelik



Karee black.edition, četvrtasta plosnata rozeta, matirana crna boja ■ NOVO



Vallis okrugla rozeta, matirani plemeniti čelik



Vento okrugla rozeta, matirani plemeniti čelik

Okovi za potpuno staklena vrata



Set okova Aronda Combi, matirani plemeniti čelik, polirani plemeniti čelik ili EV 1



Set okova Purista Combi, matirani plemeniti čelik, polirani plemeniti čelik ili EV 1



Set okova Conica Combi, matirani plemeniti čelik ili EV1



Set okova Mina Combi, matirani plemeniti čelik



Set okova Purista Combi, black edition, matirana crna boja ■ **NOVO**



Apart, matirani plemeniti čelik ili polirani/matirani plemeniti čelik



Basica 3, matirani plemeniti čelik ili EV 1



Belis, matirani plemeniti čelik



Dee, matirani plemeniti čelik, polirani plemeniti čelik ili EV 1



Grafica, matirani plemeniti čelik ili polirani plemeniti čelik



Nala, matirani plemeniti čelik ili polirani plemeniti čelik



Quadriga matirani plemeniti čelik



Linea, matirani plemeniti čelik, polirani plemeniti čelik ili EV 1



Linea black.edition, matirana crna boja ■ **NOVO**



Karee black.edition, matirana crna boja ■ **NOVO**

Crno je u trendu!



Sve su popularnije tamne boje s istaknutim crnim detaljima. Hörmann nudi za drvena i staklena vrata brojne okove, od sada i za liniju black.edition. Čak i na svijetlim površinama je izazovan kontrast!

Elegantan okov za staklena vrata



Ovaj novitet za staklena vrata može se umetnuti u kombinaciji s drvenim ili sa čeličnim dovratnicima. Minimiziran izgled profila okova djeluje vrlo elegantno. Praktično: za otvaranje vrata nije potrebno pritisnuti ručku.

Oble ručke za klizna vrata



Obla ručka 6402 za drvena vrata, okrugla, matirani plemeniti čelik ili black.edition

Design oble ručke 3649 za drvena vrata, ovalno, matirani plemeniti čelik



Design oble ručka 3648 za drvena vrata, četvrtasta, mat plemeniti čelik



Obla ručka FSB 4212, ovalna, matirani plemeniti čelik ili aluminij



Obla ručka FSB 4250, pričvršćenje za potisak, mat plemeniti čelik (za drvena vrata)



Obla ručka FSB 4251, četvrtasta, pričvršćena za guranje, matirani plemeniti čelik



Obla ručka FSB 4252, okrugla, pričvršćenje za potisak, mat plemeniti čelik



Obla ručka FSB 4253, četvrtasta, pričvršćena za guranje, matirani plemeniti čelik



Obla ručka Norma 3657, ovalna, mat plemeniti čelik



Obla ručka Rondell 3659, okrugla, matirani nikel

Rukohvati za klizna vrata



Par rukohvata Basic, obli, mat plemeniti čelik



Par rukohvata U-Grip, obli, mat plemeniti čelik



Kombinacija rukohvata Combi, plosnata ručka

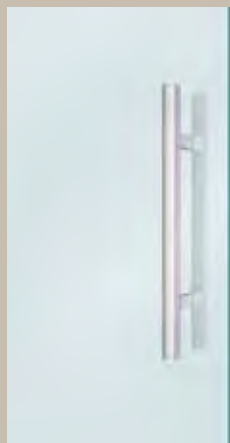

Par rukohvata Basic, četvrtastih, mat plemeniti čelik

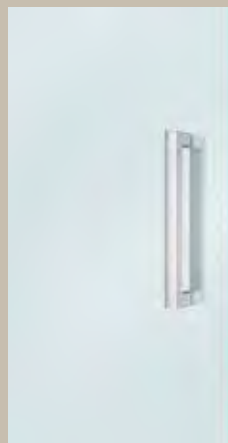

Par rukohvata U-Grip, četvrtasti, mat plemeniti čelik



Pričvrtna ploča, black.edition ■ **NOVO** Nalik plemenitom čeliku (slika dolje)



Kod kliznih vrata koja ulaze u zid, vratno krilo koje je potpuno gurnuto u zid možete pomoću skočne ručke, pritiskom na tipku, ponovo izvaditi i zatvoriti vrata.



Klizna vrata koja se kreću ispred zida mogu se potpuno otvoriti pomoću rukohvatne ploče.

Okovi za vrata koja se naslanjaju na vratna krila



BB-brava Klasa I, stulp u niklanom srebru (serijski)



Magnetne brave za nježno i tiho zatvaranje vrata (opcionalno)



3-dijelni rolo okov V 7888 WF 3D (opcija, samo za drveni dovratnik)



Skriveni 3D-okov DX 61 (opcija)



Skriveni Euro okovi (opcija) ■ **NOVO**

Okovi za vratna krila koja se preklapaju



BB-brava Klasa I, stulp u niklanom srebru (serijski)

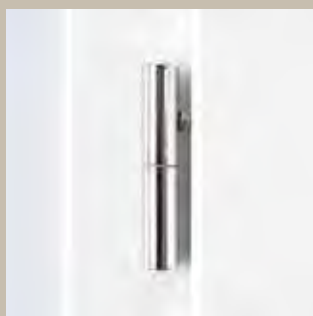

2-dijelni okov V 3420 WF (serijski)



3D-okov VX 160-18 (opcionalno)



3-dijelni okov V 4426 WF (opcija)



Skriveni okov Pivota FX 2 60 3D (opcija)

Kvalitetne površine, razne boje i ukrasi koji će uljepšati svaki dan



Duradecor glatki

- 48 % otporniji na udarce od prosjeka provjerenih CPL-površina drugih proizvođača
- Higijenski i jednostavno održavanje
- Antistatički i otporan na svjetlost
- Otporan na povećane temperature, otporan na habanje
- Otporan na djelovanje uobičajenih tekućina, pasta koje se koriste u kućanstvu, itd.

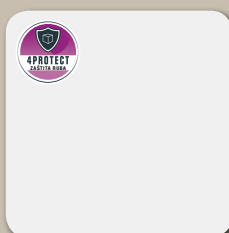

Bijeli lak
RAL 9016



Bijela



Pepeljasto siva



Svijetlo siva
RAL 7035



Svijetlo siva



Zaštita ruba 4Protect

- Izrazito dobra otpornost na udarce
- Izrazito dobra otpornost na habanje
- Izrazito dobra otpornost na ogrebotine
- Savršeni izgled bez fuga, što znači bez vidljivih fuga za vizualno izrazito zahtjevne situacije.



Talijanski bagrem



Kanadski javor



Francuska bukva



Duradecor struktura

- Karakteristična struktura drveta zahvaljujući utisnutoj strukturiranoj površini nalik drvetu
- 48 % otporniji na udarce od prosjeka provjerenih CPL-površina drugih proizvođača
- Higijenski i jednostavno održavanje
- Antistatički i otporan na svjetlost
- Otporan na povećane temperature, otporan na habanje
- Otporan na djelovanje uobičajenih tekućina, pasta koje se koriste u kućanstvu, itd.



Sivi hrast



Sivi hrast
(Poprečno)



Bijeli hrast

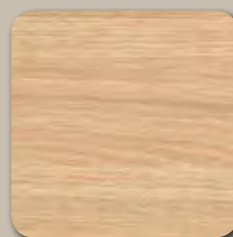

Bijeli hrast
(Poprečno)



Divlji hrast



Divlji hrast
(Poprečno)



Sirovi hrast



Sirovi hrast
(Poprečno)



Tamni hrast



Španjolski hrast



Španjolski hrast
(Poprečno)



Orah



Četkani slani hrast



Četkani bor



Četkano bijela

■ NOVO



Zaštita ruba 4Protect

- Izrazito dobra otpornost na udarce
- Izrazito dobra otpornost na habanje
- Izrazito dobra otpornost na ogrebotine
- Savršeni izgled bez fuga, što znači bez vidljivih fuga za izrazito zahtjevne situacije

Ultra mat

- Nježna površina
- Duradecor površina izrazito otporna na udarce
- Površina neosjetljiva na otiske prstiju za manje otisaka i nečistoća
- Može se pisati sa kredom



Ultra mat
Prometno bijela



Ultra mat
Svijetlo siva

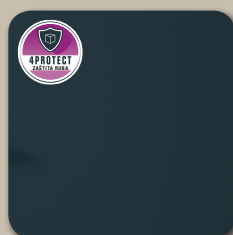

Ultra mat
Antracit siva



Ultra mat
Sivo smeđa ■ **NOVO**

Gloss

- Visoki sjaj
- Izrazito glatka površina
- Izdržljivo



Gloss
Prometno bijela



Gloss
Svijetlo siva

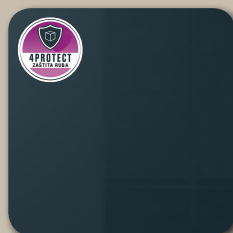

Gloss
Antracit siva



Gloss
Sivo smeđa ■ **NOVO**

Struktura kamena škrljevca

- Reljefne strukture
- Kontrast mat i sjaj
- Izdržljivo



Dojam četkane
površine
Prometno bijela



Dojam četkane
površine
Svijetlo siva



Dojam četkane
površine
Antracit siva



Dojam četkane površine
Sivo smeđa ■ **NOVO**

Lan ■ **NOVO**

- Fina struktura prirodnog izgleda
- Duradecor površina izrazito otporna na udarce

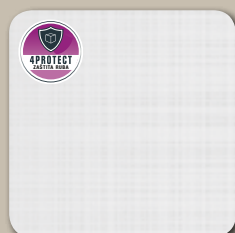

Lan
Prometno bijela



Lan
Svijetlo siva

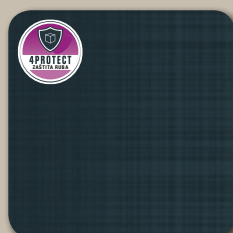

Lan
Antracit siva



Lan
Sivo smeđa ■ **NOVO**



Lak

- Jednakojerna površina
- PUNE i briljantne boje
- Lakiranje na bijeloj Duradecor osnovnoj ploči
- Po želji u RAL boji po izboru



Prometno bijela
RAL 9016



Čisto bijela
RAL 9010



Svijetlo siva
RAL 7035



Antracit siva
RAL 7016

Drveni furnir

- Od kvalitetne vrste drveta
- Površinu trajno štiti zaštitni lak, koji je u skladu s okolišem
- Prirodne linije
- Dugotrajna kvaliteta



Javor



Javor poprečno
■ NOVO



Bukva



Bukva poprečno
■ NOVO



Jasen
■ NOVO



Limba
■ NOVO



Limba za premaz
■ NOVO



Gorski hrast
■ NOVO



Američki hrast
■ NOVO



Američki hrast
poprečno
■ NOVO



Razgranati hrast
■ NOVO



Poprečno razgranati
hrast
■ NOVO



Hrast s mat lakom
■ NOVO



Uljem premazan
stari rast
■ NOVO



Američki orah
■ NOVO



Američki orah
poprečno
■ NOVO



Bajcani hrast
■ NOVO



Macore
■ NOVO



Mahagoni
■ NOVO

Kvalitetna stolarija za velike zahtjeve

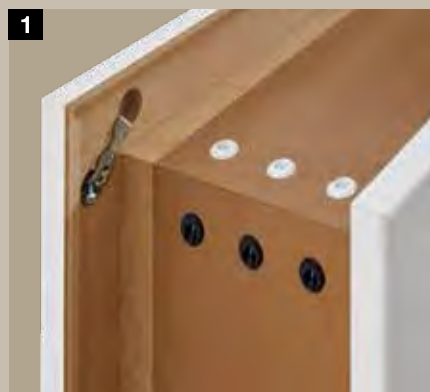

1 Lijepi izgled zahvaljujući kutnim spojevima napravljenim po mjeri koji se lako montiraju

Drveni uložak

- Kutni spojevi vijcima pričvršćeni s ispunom
- Dobra mogućnost podešavanja
- Visoka otpornost

Obloga

- Vijčani spoj od punog metala
- Izvrsna otpornost
- Izravna podjela pritiska na veznim površinama
- Na oblozi nema vidljivih provrta

2 Velika stabilnost oblika zahvaljujući robusnoj konstrukciji dovratnika

- Drveni uložak jačine 25 mm
- Drveni uložak s Duradecor površinom
- Nasuprotna strana sa slojem melamina
- Obloga od MDF

3 Trajno tiho zatvaranje zahvaljujući kvalitetnoj brtvi

- Sustav dvije komore
- Čisti mehanizam na vratnom krilu
- Dobra svojstva prigušivanja

4 Više sigurnosti zahvaljujući otpornoj standardnoj pločici za zaključavanje

- Pokretna stražnja obloga
- Pričvršćeno sa šest vijaka
- Dvostruko zatvaranje
- Dostupni kompleti za preoblikovanje

1

2

3

4

7

8



5 Nema spuštanja vrata zbog džepića za okove

- Nosivost 80 kg
- Ojačani nosač metalne konstrukcije ■ **NOVO**
- Višestruko vijcima pričvršćeno u dasku ispune
- Okov do prednjeg djela obloge
- Za drvena i potpuno staklena vrata



6 Vrlo velika stabilnost vratnog krila s ojačanim okvirom

- Unutarnja vrata s ojačanim okvirom od 80 mm
- Na strani okova i brave



7 Oblikom lijepi, zaobljeni rub od kvalitetnog temeljnog materijala



8 Robusni četvrtasti rub s 4Protect zaštitom ruba



- Izrazito dobra otpornost na udarce
- Izrazito dobra otpornost na habanje
- Izrazito dobra otpornost na ogrebotine
- Savršeni izgled bez fuga, odnosno, za razliku od uobičajenih vrata u ovom slučaju vidljive fuge **9** ne narušavaju kvalitetan izgled vrata
- Serijski s vratima koja se preklapaju na rub dovratnika, s četvrtastim rubovima, ili vratima koja se zatvaraju u ravnini s Duradecor površinom od bijelog laka, svijetlosive boje, antracit sive boje



10 Moderna boja























- Standardni bijeli lak RAL 9016

Jaka Duradecor površina

- Izrazito otporna na udarce i ogrebotine
- Svijetla, otporna na visoke temperature



Motivi vrata

		BaseLine	Design-Line Concepto	Design-Line Stripe	Design-Line Groove	Design-Line Steel	Design-Line Plain	Design-Line Rail	Design-Line Pure	Classic-Line Georgia	Classic-Line Carolina	Classic-Line Montana	Classic-Line Kontura	Classic-Line Virginia
Površine														
Duradecor														
Četvrtaste strukture		●	-	○	-	●	●	●	●	●	-	-	-	-
Oble strukture		●	-	-	-	●	●	●	●	●	-	-	-	●
Ravno četvrtasto		●	-	○	-	●	●	●	●	●	-	-	-	-
Duradecor struktura														
Četvrtaste strukture		●	-	-	-	●	●	●	●	○	-	-	-	-
Oble strukture		●	-	-	-	●	●	●	●	○	-	-	-	-
Ravno četvrtasto		●	-	-	-	●	●	●	●	○	-	-	-	-
Drveni furnir														
Četvrtaste strukture		●	-	-	-	-	-	●	-	○	-	-	-	-
Oble strukture		○	-	-	-	-	-	○	-	○	-	-	-	-
Ravno četvrtasto		●	-	-	-	-	-	●	-	○	-	-	-	-
Lak														
Četvrtaste strukture		●	-	-	●	●	●	●	●	●	-	-	-	-
Oble strukture		●	-	-	●	●	●	●	●	●	○	○	○	-
Ravno četvrtasto		●	-	-	●	●	●	●	●	●	-	-	-	-
Ultra mat														
Četvrtaste strukture		-	●	-	-	●	-	-	-	-	-	-	-	-
Oble strukture		-	●	-	-	●	-	-	-	-	-	-	-	-
Ravno četvrtasto		-	●	-	-	●	-	-	-	-	-	-	-	-
Gloss														
Četvrtaste strukture		-	●	-	-	-	-	-	-	-	-	-	-	-
Ravno četvrtasto		-	●	-	-	-	-	-	-	-	-	-	-	-
Dojam četkane površine														
Četvrtaste strukture		-	●	-	-	-	-	-	-	-	-	-	-	-
Ravno četvrtasto		-	●	-	-	-	-	-	-	-	-	-	-	-
Lan														
Četvrtaste strukture		-	●	-	-	-	-	-	-	-	-	-	-	-
Oble strukture		-	●	-	-	●	-	-	-	-	-	-	-	-
Ravno četvrtasto		-	●	-	-	-	-	-	-	-	-	-	-	-

● = dostupno za sve dekore / boje

○ = nije dostupno za sve dekore / boje

Ispuna vratnog krila

Saćasti uložak	Iverica s cijevima	Ploča od iverice prožeta cjevastim otvorima	Ploča od pune iverice
•	-	•	•
-	•	•	•
-	-	•	•
•	-	•	•
-	•	•	•
-	-	•	•
-	•	•	•
-	○	○	○
-	•	•	•
-	-	•	•
-	•	•	•
-	•	•	•
-	-	•	•
-	-	•	•
-	-	•	•
-	-	•	•
-	-	•	•
-	-	•	•
-	-	•	•
-	-	•	•
-	-	•	•
-	-	•	•
-	-	•	•
-	-	•	•
-	-	•	•
-	-	•	•
-	-	•	•



Saćasti uložak

Sa sačastim uloškom dobivate oblikom stabilno punjenje vrata, koje će Vas oduševiti po pitanju odnosa cijene i učinka.



Cijevasta iverica

Uložak vratnog krila sastoji se od pojedinih otvora koji su međusobno optimalno raspoređeni. Stoga je vratno krilo vrlo stabilno i prikladno za zahtjevnu uporabu.



Ploča od iverice prožeta cjevastim otvorima

Ploča prožeta vodoravnim cijevima vratnim krilima daje izrazitu stabilnost površine. Ova kvaliteta sobna vrata prikladna su za još zahtjevnije uvijete uporabe.



Ploča od pune iverice

Kvalitetna vratna krila od masivne pune iverice najkrutija su krila te su posebno prikladna za još zahtjevniju uporabu. Vrata sa svjetlosnim otvorima serijski se isporučuju s pločama od pune iverice.

Izvedbe dovratnika



Sveobuhvatni dovratnik sa zaobljenim rubom



Sveobuhvatni dovratnik s četvrtastim rubom (samo za lakiranu površinu)



Sveobuhvatni dovratnik profiliran za ClassicLine Georgia i Carolina



Blok dovratnik

Vratno krilo

- Debljine oko 40 mm
- Konstrukcija okvira od punog drva / drvenog materijala s dodatni ojačanjem okvira, dolje moguće skraćivanje 25 mm
- Za dvokrilna vrata: izvedba nasuprotnog preklopa*
- Klasa klime I Kategorija opterećenja N do S (ovisno o izvedbi)
- Izrađeno prema DIN 18101
- Prikladno za obuhvatne drvene dovratnike ili standardne čelične dovratnike

Dovratnik

- Obloga preklopa 16 × 60 mm, rezana na koso i čvrsto spojena s punjenjem. Po želji 16 × 80 mm
- Daska ispune od iverice od 25 mm, obloga preklopa i ukrasna obloga od MDF ploče debljine 12 mm
- Ukrasna obloga 16 × 60 mm, po izboru 16 × 80 mm
- Podesivo u skladu s debljinom zida – 5 mm / + 15 mm
- Prigušni profil je tvornički uvučen, rezan koso

Vertikalni presjek

S preklomom

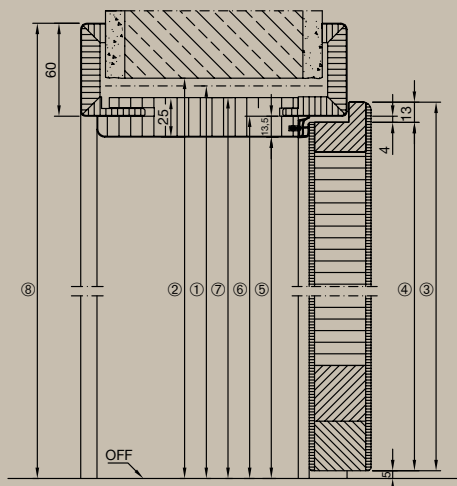

Ravno

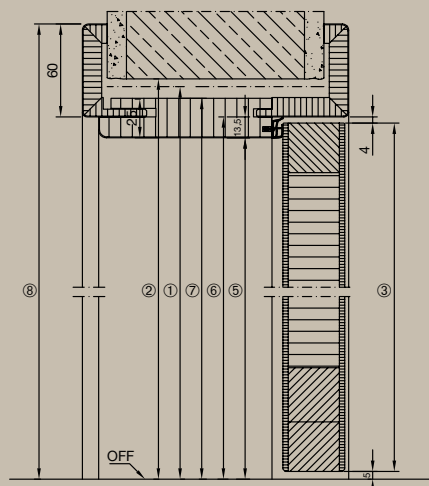

1 Okvirna građevinska visina		1875	2000	2125	2250
2 Otvor u zidu		1880	2005	2130	2255
3 Vanjska mjera vratnog krila	S preklomom	1860	1985	2110	2235
	Ravno	1847	1972	2097	2222
4 Dimenzija ispune vratnog krila		1847	1972	2097	2222
5 Svjetla dimenzija prolaza		1843	1968	2093	2218
6 Dimenzija preklapanja na dovratniku		1856	1981	2106	2231
7 Vanjska dimenzija ispune		1868	1993	2118	2243
8 Vanjska mjera obloge Za oblogu od 60 mm (Za oblogu od 80 mm + 20 mm)		1916	2041	2166	2291

Izvedbe dovratnika

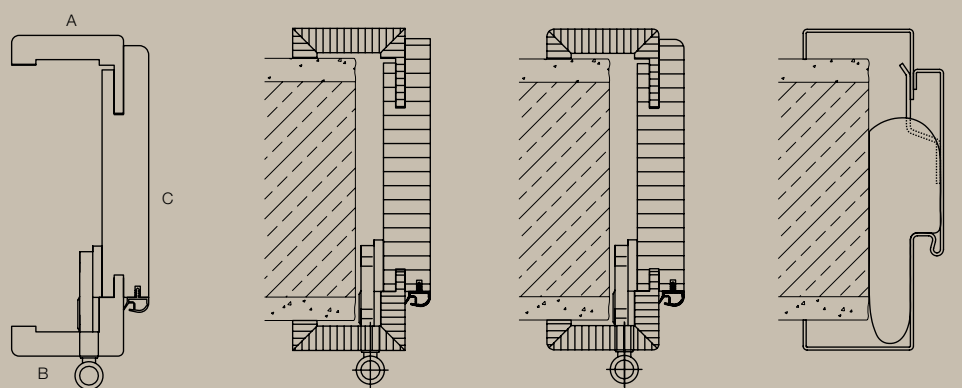

A: Ukrasna obloga
B: Obloga za prekop
C: Drveni uložak

Drveni dovratnik, četvrtasti

Drveni dovratnik, zaobljeni

Okvir s čeličnom ispunom VarioFix

Vodoravni presjek Horizontalni presjek – jednokrilna

S preklopom

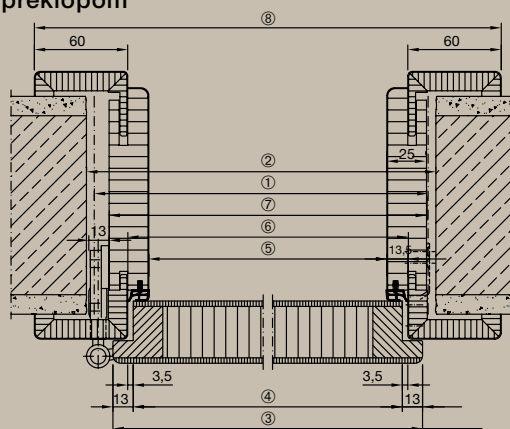

Ravno

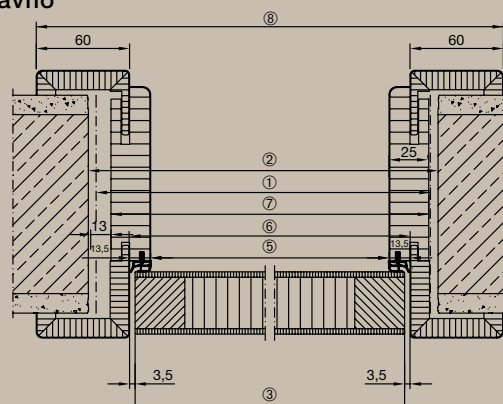

		625	750	875	1000	1125	1250
1 Okvirna građevinska širina		625	750	875	1000	1125	1250
2 Otvor u zidu		635	760	885	1010	1135	1260
3 Vanjska mjera vratnog krila	S preklopom	610	735	860	985	1110	1235
	Ravno	584	709	834	959	1084	1209
4 Dimenzija ispune vratnog krila		584	709	834	959	1084	1209
5 Svjetla dimenzija prolaza		564	689	814	939	1064	1189
6 Dimenzija preklapanja na dovratniku		591	716	841	966	1091	1216
7 Vanjska dimenzija ispune		614	739	864	989	1114	1239
8 Vanjska mjera obloge		711	836	961	1086	1211	1336

Vodoravni presjek – dvokrilna

S preklopom

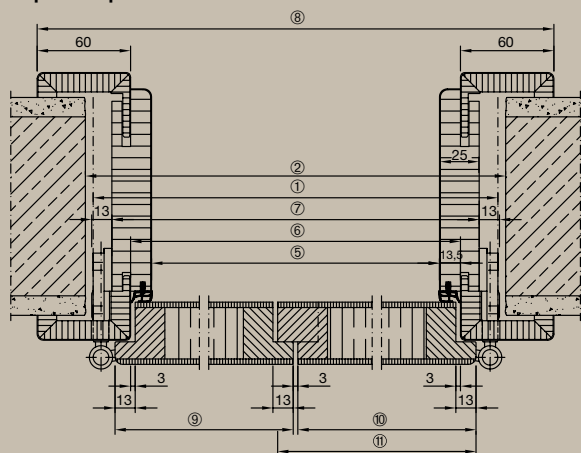

Ravno

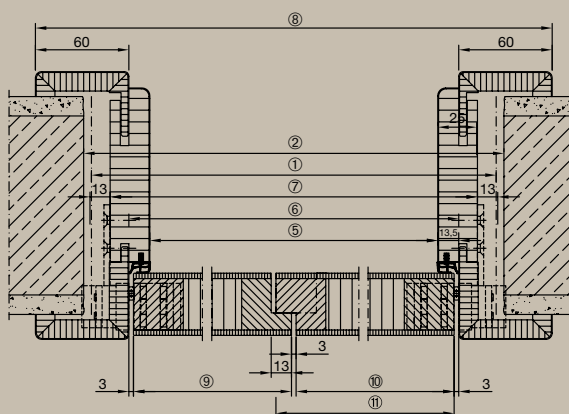

		1250	1375	1500	1750	1875	2000	2250	2500
1 Okvirna građevinska širina		1250	1375	1500	1750	1875	2000	2250	2500
2 Otvor u zidu		1260	1385	1510	1760	1885	2010	2260	2510
5 Svjetla dimenzija prolaza		1176	1301	1426	1676	1801	1926	2176	2426
6 Dimenzija preklapanja na dovratniku		1203	1328	1453	1703	1828	1953	2203	2453
7 Vanjska dimenzija ispune		1226	1351	1476	1726	1851	1976	2226	2476
8 Vanjska mjera obloge		1323	1448	1573	1823	1948	2073	2323	2573
9 Vanjska mjera vratnog krila	S preklopom	610	735	735	860	985	985	1110	1235
	Ravno	597	722	722	847	972	972	1097	1222
10 Vanjska mjera vratnog krila	S preklopom	610	610	735	860	860	985	1110	1235
	Ravno	597	597	722	847	847	972	1097	1222
11 Vanjska mjera vratnog krila	S preklopom	623	623	748	873	873	998	1123	1248
	Ravno	610	610	735	860	860	985	1110	1235

* Samo za motive vrata Carolina

Sve dimenzije u mm



Hörmann kvaliteta za novogradnju i renoviranje

S Hörmann proizvodima možete sve planirati. Pažljivo usklađena rješenja nude vrhunske i izrazito funkcionalne proizvode.

- **Garažna vrata**

Optimalno usklađena s Vašim osobnim arhitektonskim stilom: krilno podizna ili sekcijaska vrata od čelika ili drva.

- **Pogoni za kućna i garažna vrata**

Uživajte u vrhunskoj udobnosti i zaštiti od provale s Hörmann motorima za garažna i dvorišna vrata. Hörmann motore za vrata možete koristiti i iz udobnosti svoga doma.

- **Kućna vrata**

U našoj velikoj ponudi kućnih vrata naći ćete motiv vrata po Vašoj želji i za svaku priliku.

- **Čelična vrata**

Vrata za svaki dio kuće, od podruma do potkrovlja.

- **Dovratnici**

Program dovratnika za adaptaciju objekata i novogradnju.



Garažna vrata i motori



Kućna vrata



Čelična vrata

Hörmann: Kvaliteta jednom zauvijek



Hörmann KG Amshausen, Njemačka



Hörmann KG Antriebstechnik, Njemačka



Hörmann KG Brandis, Njemačka



Hörmann KG Brockhagen, Njemačka



Hörmann KG Dissen, Njemačka



Hörmann KG Eckelhausen, Njemačka



Hörmann KG Freisen, Njemačka



Hörmann KG Ichtershausen, Njemačka



Hörmann KG Werne, Njemačka



Hörmann Alkmaar B.V., Nizozemska



Hörmann Legnica Sp. z o.o., Poljska



Hörmann Beijing, Kina



Hörmann Tianjin, Kina



Hörmann LLC, Montgomery IL, SAD



Hörmann Flexon LLC, Burgettstown PA, SAD



Shakti Hörmann Pvt. Ltd., Indija

Tvrtka Hörmann jedini je svjetski proizvođač koji nudi kompletan program svih osnovnih građevinskih proizvoda na jednom mjestu. Proizvodimo u visoko specijaliziranim tvornicama koristeći najnoviju tehnologiju proizvodnje. Rasprostranjena mreža trgovina i servisa diljem Europe, te u Sjedinjenim Državama i Aziji čini Hörmann Vašim jakim internacionalnim partnerom. Hörmann jednom zauvijek.

GARAŽNA VRATA
POGONI
INDUSTRIJSKA VRATA
PRETOVARNA TEHNIKA
VRATA
DOVRATNICI